

SALVIS VitalityEVO-Easy Pressure Steamer

SALVIS VitalityEVO-Pro Pressure Steamer

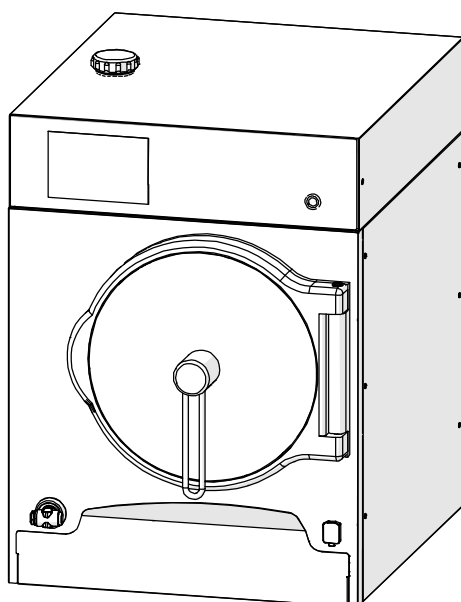

Operating instructions

en-GB

Translation of the original operating instructions

Read the operating instructions before installing and commissioning the appliance!

1.	User information	4
1.1	Important information about these operating instructions	4
1.2	Symbols in front of the text	4
1.3	Warning icons	4
1.4	Signal words	4
1.5	Intended use	5
1.6	Misuse	5
1.7	Entering type plate data	5
2.	Safety instructions	6
3.	Description of the appliance	8
3.1	Description of the functional components	8
3.2	Familiarise yourself with the control/display panel	9
3.2.1	Overview of control system variants	9
3.2.2	Instructions for using the touch screen	10
4.	Commissioning	11
4.1	Preparing the appliance for use	11
4.2	Switching on the appliance	13
4.3	Filling the cooking chamber	13
4.4	Working with the core temperature sensor (optional)	14
4.5	Starting/ending the cooking process	15
4.5.1	Starting the cooking process	15
4.5.2	Ending the cooking process	16
4.5.3	Removing the containers	16
4.6	Using the pull-out shower head with automatic retraction (optional)	17
5.	Finishing up – Switch off the appliance	17
5.1	If there is a risk of frost or before long stoppage times	17
6.	Using operating modes and cooking programs	18
6.1	Configuring the cooking process – manual settings	18
6.2	Adding cooking steps/combinations	22
6.3	Using revitalisation	25
6.4	Using cooking methods	26
6.5	Using special programs	27
6.6	Using cooking programs from the cookbook	28
6.7	Working with categories (menu groups)	30
6.8	Working with favourites (preferred products)	31
7.	Creating, changing and deleting cookbook products	33
7.1	Creating, saving and assigning products	33
7.2	Changing settings for products in the cookbook	37
7.3	Deleting a product from the cookbook	38
7.4	Creating and deleting categories	39
7.4.1	Creating categories	39
7.4.2	Deleting categories with products	40

8.	Displaying and exporting HACCP logs	43
8.1	Displaying HACCP logs	43
8.2	Exporting HACCP logs to a USB drive	44
9.	Configuring the control system and user interface	45
10.	Exporting and importing data	57
10.1	USB data storage media requirements (USB drive)	57
10.2	Data export: Information about the data structure on the USB drive	58
10.3	Data import: information about the "Replace/Add" key	59
10.4	Exporting data – save data example	60
10.5	Importing data – replace cookbook(s) example	61
11.	Cleaning and care	63
11.1	Important information about stainless steel (risk of corrosion)	63
11.2	Cleaning stainless steel surfaces	63
11.3	Cleaning and care of the seal on the cooking chamber door	64
11.4	Cleaning the cooking chamber and the drip tray	64
11.5	Rinsing and cleaning the drain and valves	65
12.	Regenerating the water softener	66
12.1	Regeneration prompts	66
12.2	Starting the regeneration process	66
13.	Faults and troubleshooting	69
14.	Technical data	73
15.	Setup and connections	73
15.1	Appliance warm-up	73
15.2	Transporting the appliance	74
15.3	Information about the installation site	74
15.4	Setup	75
15.5	Connections	76
15.6	Water connection	76
15.7	Water drain	77
15.8	Connecting to the electrical power supply	77
15.9	Connecting to an energy optimisation unit (optional)	78
15.10	Connecting to a load-shedding unit (optional)	78
15.11	Settings – water softener and height above sea level	79
15.12	Commissioning	79
16.	Maintenance	80
17.	Disposing of old appliances	80
18.	Translation of ECDeclaration of Conformity	81
19.	Software declaration	81

1. User information

Thank you for choosing a product made by SALVIS . It is very important to us that you enjoy your SALVIS product, and find that it makes your work easier and more productive.

1.1 Important information about these operating instructions

Please read the operating instructions carefully before starting to use the appliance.

The operating instructions contain important information about correct operation, setup and installation. Please pay particular attention to the information about safe use.

Always keep the documents supplied with the appliance within easy reach and pass these on to a new owner of the appliance.

As the operating company, ensure that personnel who work with/on the appliance have access to the operating instructions.

1.2 Symbols in front of the text

 You are requested to perform an action.

- Bullet points or list
- Important information, sequence of operations



Note Notes that provide particularly useful information and tips

1.3 Warning icons



Warning about danger points



Warning about dangerous electric voltage



Warning about hot surfaces

1.4 Signal words

DANGER

A warning about **life-threatening** injuries.

WARNING

A warning about **serious** injuries.

CAUTION

A warning about **minor to moderate** injuries.

IMPORTANT

A warning about property damage.

1.5 Intended use

- The appliance must be used only for cooking, steaming, regenerating or heating food, or keeping food warm.
- The appliance is for commercial use and must be operated as follows:
 - By instructed and trained personnel
 - With the drip tray inserted
 - When appliance use is supervised
 - For the purpose designated in the operating instructions
- Any other use beyond this use is considered to be a non-intended use.
- The user is solely responsible for any damage caused by a non-intended use.
- Any and all misuse of the appliance voids both the manufacturer's warranty and the manufacturer's general liability.
- Do not make any modifications to this appliance.

1.6 Misuse

- Do not use the appliance as a storage unit or work surface.
- The appliance must not be used for heating, drying and storing objects, or for heating and melting process materials.
- Do not place flammable objects or objects that are easily ignited into the cooking chamber.
- The appliance must not be operated outdoors.
- The following persons must not use the appliance:
 - Children
 - Persons with restricted physical, sensory or mental abilities
 - Untrained personnel

1.7 Entering type plate data

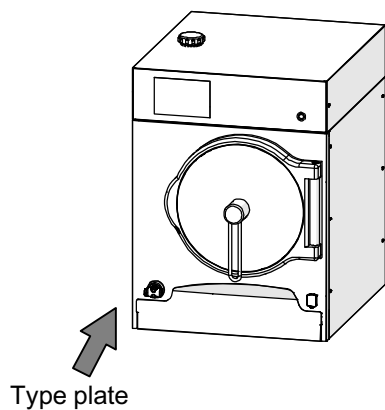

Please write the type plate data in the spaces provided below before installing the appliance. Please provide these details if you require after-sales service for the appliance. This will speed up the handling of your enquiry.

Type and article number:

Serial number (s. no.):

Production date (year of manufacture):

2. Safety instructions



- Packaged products must be cooked only in heat-resistant containers that have been approved for food use.
- Do not store sensitive foods in the temperature range 10–70°C in the cooking chamber for prolonged periods. Bacteria can multiply very rapidly at temperatures within this range.
- When using the start time selection function, please note: Bacteria can multiply very quickly in food in the cooking chamber that has not been chilled or heated.
- Please observe the rules and regulations as set out by trade associations.
- Please follow the instructions for "Cleaning" in this document, *see from page 63, section 11.*

DANGER! Comply with national work safety legislation to determine and assess hazards

- In Germany, for example, employers are required by law to assess the hazards for employees when carrying out their work, and the health and safety measures that are necessary. A further example is provided by the guidelines from the German trade association for operators of commercial kitchens.
- The employer must specify and supply employees with personal protective equipment.

WARNING! Risk of injury!



- During operation there is a risk of burns from the following:
 - Hot surfaces
 - Hot Gastronorm containers
 - Hot cooked products
 - Hot removable racks
 - Hot drip trays
 - Hot steam escaping when the cooking chamber door is opened
- Risk of burn injuries! Take care when opening the cooking chamber door – hot air and steam may escape. Always open the cooking chamber door slowly and carefully. Wear waterproof and heat-resistant protective gloves.
- During the heating-up process, steam in the cooking chamber can escape: as a result, do not work in the cooking chamber during this process. Close the cooking chamber door before the heating-up process.



- Risk of scalding! When removing liquid cooked products, spilled product can cause scald injuries. Ensure that operating personnel have a clear view of the containers in the cooking chamber. The appliance must be installed so that the height of the upper input module does not exceed 1.60 metres/63 inches.
- Remember that filled Gastronorm containers are heavy! Always work with proper back posture.
- Slip hazard! Remove water or food that has been spilt on the floor immediately.
- Crush hazard! Do not reach between the cooking chamber door and cooking chamber when closing the cooking chamber door. Do not reach into the locking mechanism when locking the cooking chamber door.

- The water softener lid must not be removed while the appliance is in use.
- The appliance must not be operated if the mains cable/mains plug is damaged. To avoid the risk of electric shock, the mains cable/mains plug must be replaced by an authorised customer service technician or electrician.
- Do not continue to use the appliance if the control panel glass is damaged.
- Do not move appliances/platform trolleys on castors over uneven floors or over sills or protrusions. Platform trolleys and appliances on castors can tip over when moved across uneven floors or over door sills!
- For appliances on castors, the manoeuvrability of the appliance must be restricted enough to prevent any damage to its supply and waste lines. Secure the appliance again with the safety chain after transportation (see installation instructions).
- As an appliance operator, make sure you know where the circuit breaker is located in the building for the appliances you are operating. This means you can shut down the appliance safely in the event of fire or damage.

IMPORTANT! Risk of damage!

- Do not heat permanently sealed containers such as cans of food. The sealed containers or cans could explode.
- To avoid corrosion damage to the appliance, do not place any salted food or liquids into the cooking chamber. Also see the information about adding salt to dishes on page 13 , section 4.3.
- The ambient temperature at the installation site must not fall below freezing. Otherwise, water in the pipes and components will freeze, and this will damage the appliance. Contact the authorised Customer Service if water-bearing components need to be drained.
- Do not spray or clean the appliance with water hoses, pressure washers, high-pressure steam cleaners or steam cleaners.
- Do not spray foam cleaner onto front panels or appliance enclosures. Foam cleaner seeps into the appliance, where it can then destroy components.
- If the appliance has not been used for some time, have it inspected by the authorised Customer Service to ensure it is working properly.
- If you are unable to remedy faults by using the information on page 69 , section 13. “Troubleshooting”, switch off the appliance and notify the authorised Customer Service.

3. Description of the appliance

- Cooking times can be set in increments of one second/minute. This ensures you achieve the best cooking results.
- Dishes can be cooked to a precise temperature, with or without pressure. When the cooker is pressurised, temperatures exceeding 100°C are used for cooking. This considerably reduces cooking times, saving you time and energy. Vegetables retain their natural colours.
- Hot steam is fed into the cooking chamber according to the various operating modes and settings made by the operator. The higher the cooking chamber temperature, the higher the chamber pressure. The higher the cooking chamber pressure, the faster cooking completes.
- The cooking chamber door is locked during cooking methods that use a pressurised cooking chamber. The cooking chamber door cannot be opened until the chamber is no longer pressurised.
- Settings are made via the touch screen.
- The control system is used to automate the cooking methods.
- The pressure steamer is equipped with a water softener. The water softener is filled at the factory with 0.5 kg of regeneration salt. To regenerate the water softener, see page 66 , section 12..

3.1 Description of the functional components

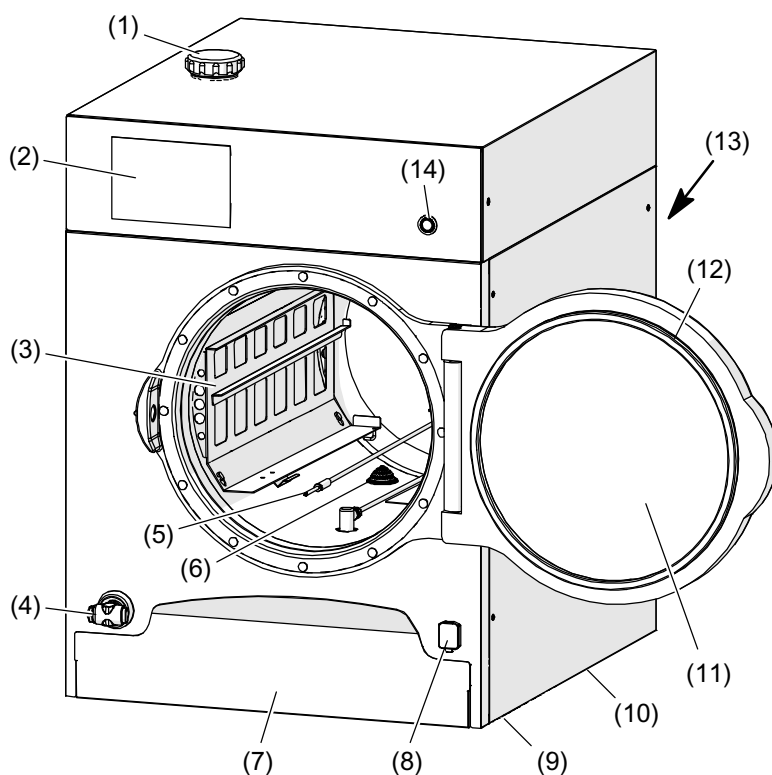

- (1) Water softener lid
- (2) Display/control panel (touch screen)
- (3) Left removable rack (with socket for core temperature sensor)
- (4) Pull-out shower head (optional)
- (5) Core temperature sensor (optional)
- (6) Drain screen, cooking chamber drain
- (7) Drip tray
- (8) USB port
- (9) Adjustable feet
- (10) Seal on housing
- (11) Cooking chamber door
- (12) Seal on cooking compartment door
- (13) Rear of appliance: network port (Ethernet/LAN)
- (14) Main appliance on/off switch

3.2 Familiarise yourself with the control/display panel

3.2.1 Overview of control system variants

After the control system is switched on and has powered up, various user interfaces appear according to the appliance's feature level.

Control system operating features for "Easy"

With operating modes:

- Revitalisation
- Cooking method
- Manual

For information about using operating modes, see page 18, section 6.1 to section 6.4

Example display

The operator can configure the "Input and display area" to suit operational circumstances.

For information about changing "Input and display area" views, see page 45, section 9., fig. 11 and 12

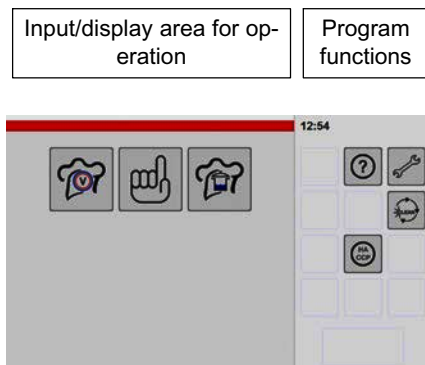

To display HACCP data, see page 43, section 8.

Special equipment

For descriptions of additional functions purchased and installed, see page 27, section 6.5

Control system operating features for "Pro"

The control system supports many different operating variants:

- Cookbook with list view
- Cookbook with pictogram view
- Own favourites list (preferred products)
- Categories as list or pictograms (grouped products)
- 20 cooking steps can be combined
- Special programs
- User-selectable assignments
- Manual settings

For information about using operating modes, see page 18, section 6.

Example display

The operator can configure the "Input and display area" to suit operational circumstances.

For information about changing "Input and display area" views, see page 45, section 9., fig. 11 and 12

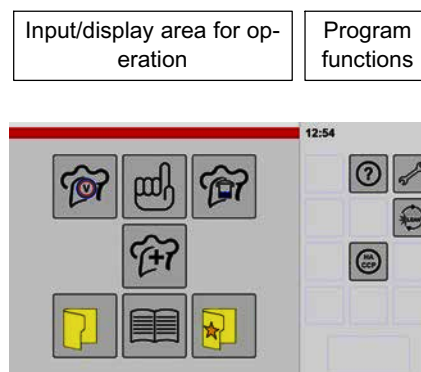

To display and export HACCP data, see page 43, section 8.

3.2.2 Instructions for using the touch screen



Fig.: Control system Pro

Control/display panel: Touch screen

- The appliance's control system is operated by using the touch screen.
- The touch screen is operated by tapping the screen with a fingertip. Only a short tap is needed.
- Do not tap the touch screen with ballpoint pens or other objects.
- The layout and number of symbols in the "Input and display area" can be customised to operator requirements. See page 45, section 9., figure 11 and 12.
- The screen brightness is reduced if no input is made for a while. Tap the screen to restore the normal screen brightness.

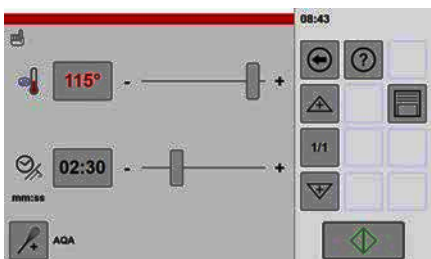

Easy operation

- The control system is easy to use. Tapping the symbols takes you to the next setting option. To practice, tap to navigate through the menus. You can always use the back key to return to the previous menu.
- If you tap and hold the back key the display switches to the "Home" symbol . The start screen is shown when you release the key.
- The help function provides you with additional context-related help in the various menus. If you tap the help key, an explanatory help message is shown. Use the exit key to close the help message.

Additional function activated/deactivated

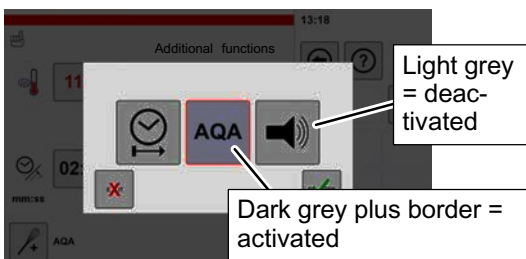

Use of light grey/dark grey

Switch symbols are shown light/dark grey and with a border depending on the various functions.

Additional function activated/deactivated

This additional function can be activated/deactivated by tapping the key.

- Light grey = additional function deactivated
- Dark grey = additional function activated

Display of possible functions

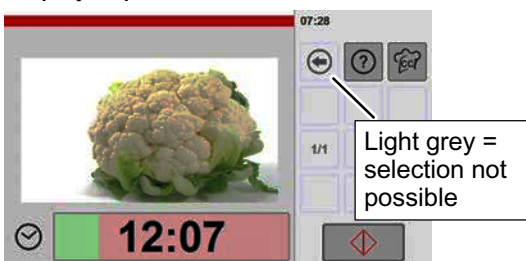

Display of possible functions

- Light grey = selection not possible
- Dark grey = can be selected

4. Commissioning

To ensure proper operation, the following specifications must be met.

- The appliance must be professionally connected (page 73 section 15.)
 - The "Water softener" and "Height above sea level (NHN)" settings must correspond to local conditions (page 79 section 15.11)
- ☞ Clean the appliance inside and outside before commissioning.
- For cleaning, see page 63 section 11.

Commissioning

⇒ For commissioning, see page 79 section 15.12.

4.1 Preparing the appliance for use

- ☞ Check to ensure that the cooking chamber is clean and free of cleaning agent residues.
- ☞ Open the water tap.
- ☞ Switch on the mains switch upstream of the appliance.

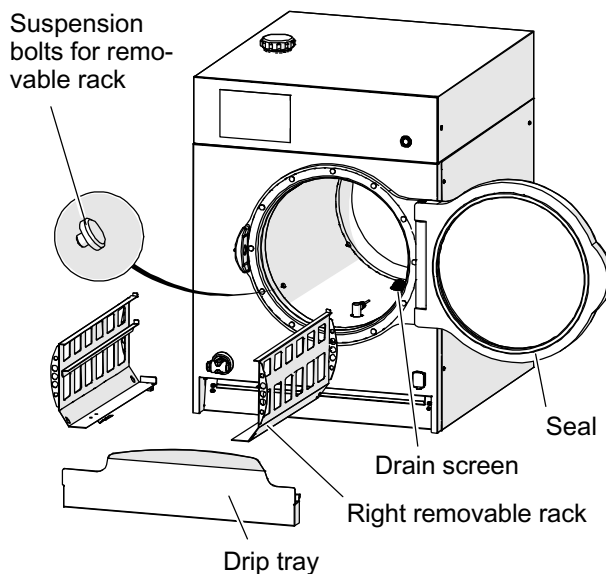

Fitting the parts

- ☞ Fit the seal to the cooking chamber door.
- ☞ Fit the drain screen to the cooking chamber drain.
- ☞ Hook the drip tray into place.
- ☞ Hook in the left and right removable racks.

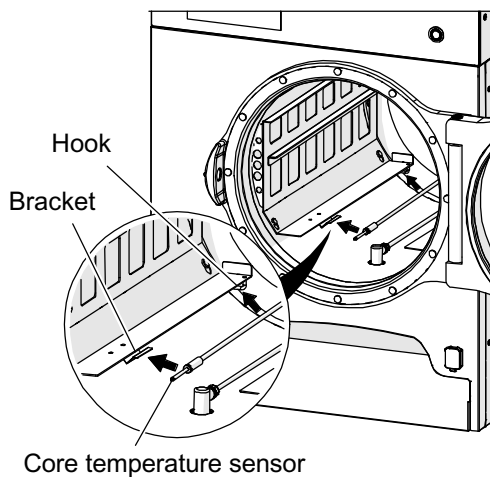

Placement of the core temperature sensor if not used

- ☞ If the core temperature sensor is not required for the cooking process:
 - Fix the cable to the hook
 - Place the core temperature sensor in the bracket
- For instructions about working with the core temperature sensor, see page 14 , section 4.4

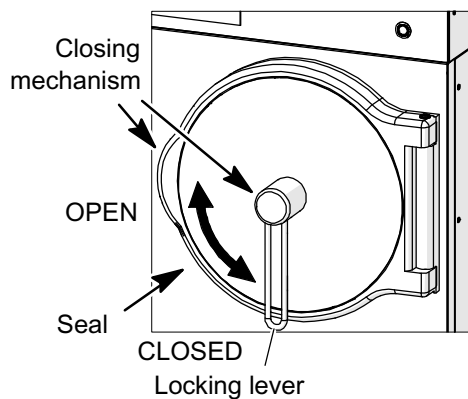

Closing the cooking chamber door



WARNING! Crush hazard! Do not reach between the cooking chamber door and cooking chamber when closing the cooking chamber door. Do not reach into the locking mechanism when locking the cooking chamber door.

- Do not slam the cooking chamber door shut.
- ☞ Close the cooking chamber door and lock it with the locking lever.

If steam escapes from the seal:

- ☞ Remove and clean the seal. Then rub a thin coat of a food-grade emulsion (kitchen oil) or cooking oil onto the seal.
- If the seal is too slack, it must be replaced or the cooking chamber door must be readjusted by Customer Service.

4.2 Switching on the appliance



CAUTION! Steam can escape in the cooking chamber during the heating-up process. Do not work in the cooking chamber during the heating-up process.

- ☞ Open the water tap.
- ☞ Switch on the mains switch upstream of the appliance.
- ☞ Close the cooking chamber door.
- ☞ Switch the appliance on – press the "On/Off" key.
 - The LED ring indicator lamp lights up.
 - An appliance logo is displayed for approx. 1 minute on the touch screen.
 - The steam system is heated up automatically (duration approx. 8 min, depending on appliance power).



Important: allow for the waiting time. The appliance is computer-controlled.

Accordingly, do not turn the appliance on and off quickly, as this could result in malfunctions. The computer control system needs a certain amount of time to load all of the data or to shut the system down properly. Accordingly, wait about 30 seconds after turning the appliance off before turning it back on again.

For instructions on product selection/changing settings, see from page 18 , section 6.

4.3 Filling the cooking chamber

- Always use heat-resistant Gastronorm containers.
- Always season your dishes with salt after the cooking process has completed to avoid corrosion damage when using perforated plates in the cooking chamber. This also means you will need less salt than you would if you season before the cooking process starts.
- Do not overfill the cooking chamber. When filling Gastronorm containers with food for cooking, stop at least 10 mm below the rim.
- Grease dripping down during the cooking process must not enter the cooking chamber drain; for these types of food, ensure that a Gastronorm container is slotted into the lowest shelf. Otherwise there is a risk of clogging the water drainage system.
- **WARNING! Hot foods can slop over. Risk of burn injuries!** Observe shelf heights for liquid foods and foods that become liquid.
- For foods that are liquid or become liquid:
 - Fill the Gastronorm container no more than 2/3 full
 - Only insert Gastronorm containers at levels that can be easily seen by operating personnel



4.4 Working with the core temperature sensor (optional)



- The internal temperature of the food being cooked is measured precisely by the core temperature sensor. Once the configured core temperature is reached, the appliance is automatically switched off and a buzzer sounds.
- The cooking time is deactivated if you use the core temperature function.
- The core temperature can be used in all cooking phases. Make sure that you choose a higher core temperature from one cooking phase to the next, otherwise the cooking process will be ended prematurely.
- Core temperature adjustment range: 0°C to 99°C.
- Benefits of the core temperature function:
 - Cooking results are uniform and optimum
 - Reductions to weight losses
 - Overcooking is avoided

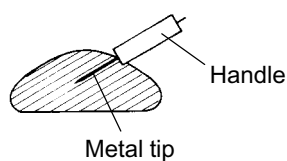
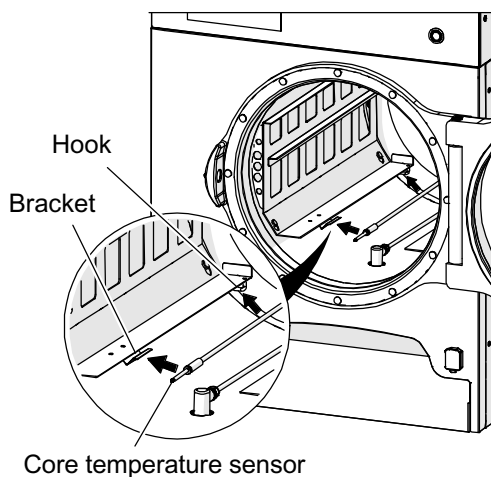

Using the core temperature sensor



CAUTION! Risk of burn injuries!
The core temperature sensor is hot.
Take care when removing.

- ☞ Insert the core temperature sensor into the food being cooked, with the tip towards the centre.
- The metal tip should be pushed fully into the food being cooked (down to the handle).

4.5 Starting/ending the cooking process

4.5.1 Starting the cooking process

For instructions on product selection/changing settings, see from page 18, section 6.

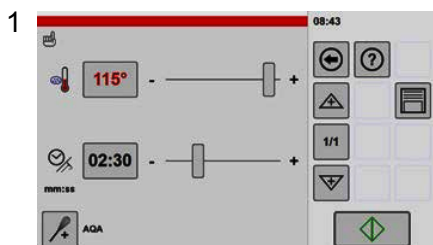

Starting the cooking process



- The symbol in the key lights up green.

Tap the "Start/Stop" key.



- The symbol in the "Start/Stop" key changes from green to red.
- The quantity/cooking time is adjusted automatically. The length of the process depends on the quantity of food in the cooking chamber. After the quantity/cooking time has been adjusted, the specified cooking process starts automatically.
- The timer runs down. The remaining time is displayed.
- The progress bar provides a graphical display of the elapsed time.
- You can change settings during the cooking process.
- Core temperature function: The cooking process does not start if the core temperature sensor is not inserted into the food to be cooked or the target temperature is not set. A prompt is shown on the display panel.

Cooking process display

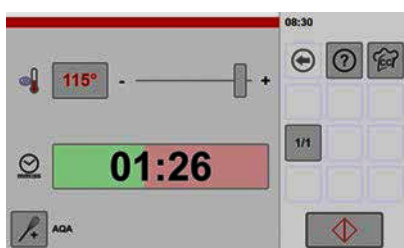

Displaying the actual temperature in the cooking chamber



Tap the "Temperature" key.

- The actual temperature is shown for approx. 5 seconds.

"Start/Stop" key display legend:



Green: The cooking process can be started.



Red: The timed cooking process is running. The cooking process can be interrupted by tapping the "Start/Stop" key.

4.5.2 Ending the cooking process



WARNING! Risk of scalding! Open the cooking chamber door carefully. Allow steam and hot air to escape in a controlled manner to avoid endangering anyone.

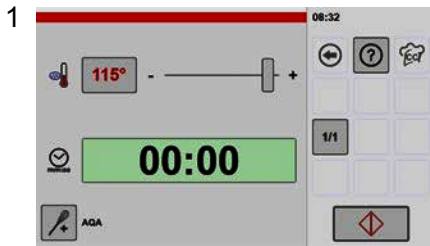

Ending the cooking process

For instructions about adjusting acoustic signals, see from page 45, section 9. (figure 6)

- An acoustic signal sounds at the end of the cooking process/when pressure returns to normal.
- Pressure is normalised automatically for cooking temperatures over 99 °C. A message "Depressurising" is shown for the duration of the process.

☞ Open the cooking chamber door.

- The cooking parameters set previously are displayed again.
- The symbol in the "Start/Stop" key changes from red to green.

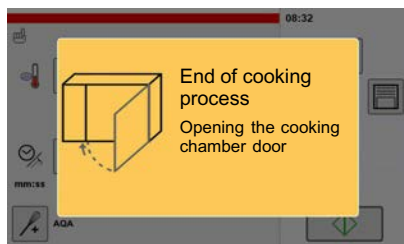
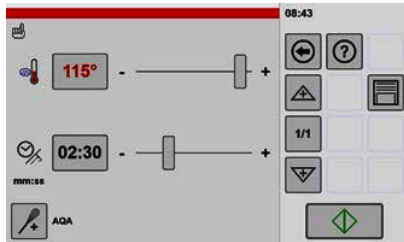

- If the "Start/Stop" key is tapped before the cooking chamber door is opened, the "Open cooking chamber door" prompt is shown.
- A new cooking process can only be started after the cooking chamber door has been opened and closed.

4.5.3 Removing the containers



WARNING! Risk of scalding! Open the cooking chamber door carefully. Allow steam and hot air to escape in a controlled manner to avoid endangering anyone.

CAUTION! Risk of burn injuries! Caution: the core temperature sensor is hot!

☞ Remove the core temperature sensor from the cooked food and insert it into its holder.

- The core temperature sensor is a sensitive measuring instrument: do not let it dangle out of the cooking chamber. Otherwise it could be damaged when the cooking chamber door is closed.



WARNING! Risk of scalding! Caution! Hot surfaces and containers! Caution! Risk of hot liquids slopping over! Wear suitable protective clothing and protective gloves.

☞ Cover containers with liquid foods before removing them to prevent any risk of scalding from liquids slopping over.

☞ Clean the cooking chamber if no more cooking processes are planned after the removal of the food. Otherwise there is a risk of clogging the drain as grease solidifies. *(For cleaning instructions, see page 63, section 11.)*

4.6 Using the pull-out shower head with automatic retraction (optional)

- Use the pull-out shower head only in the cooking chamber.
- Always ensure that the water drain can handle the amount of water you spray into the chamber.

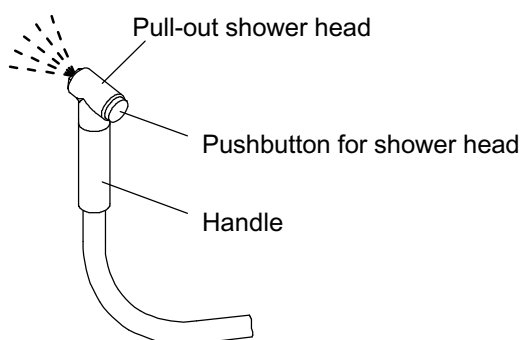

Function

- The pull-out shower head engages at several positions.
 - The pull-out shower head can be retracted between these locking points.
 - The locking points can be heard and felt.
 - The water supply is activated when the cooking chamber door is open.
- ☞ Guide the pull-out shower head back into the appliance by hand during rewinding. Do not allow it to "snap back".
- Ensure the pull-out shower head is completely retracted into the appliance after use. Otherwise, the shower head could be damaged by the cooking chamber door.

5. Finishing up – Switch off the appliance

- ☞ Clean the appliance – see page 63 section 11. "Cleaning and care".
- ☞ Switch off the appliance – tap the "On/Off" key.
- After about a second: the LED ring indicator lamp goes off (standby).
 - The display screen is switched off.
 - The steam system pressure is normalised as it cools down.
 - The appliance is still electrically live.
- ☞ Switch off the electrical main switch upstream of the appliance, or disconnect the mains plug.
- ☞ Shut off the water tap.

5.1 If there is a risk of frost or before long stoppage times

The appliance must be emptied of all water if there is a risk of frost or before long stoppage times (e.g. seasonal use). Notify your authorised customer service representative.

6. Using operating modes and cooking programs

This section 6. describes all of the options. The figures and functions may deviate from the figures shown here, depending on the features equipped for the appliance.

6.1 Configuring the cooking process – manual settings



This section (6.1) also provides you with information about basic functions and their configuration options.

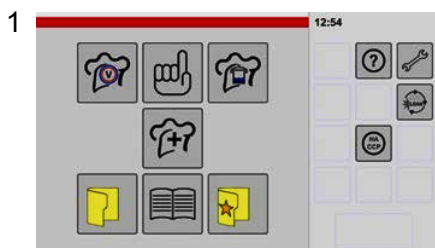

Starting manual settings



(Sample figure: feature level Pro with options).

- Tap the "Manual" key
- The "Settings" window is shown.

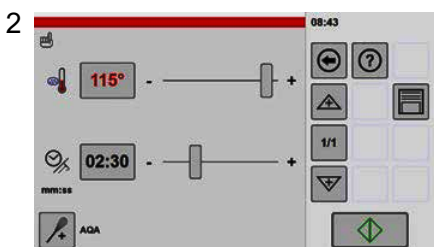

Changing settings/starting the cooking process



- Tap the "Start/Stop" key.
- The symbol in the "Start/Stop" key changes from green to red.

For information about the cooking process window, see page 15, section 4.5.1

or change the values with the slider or the numeric keypad:



- Using the slider: Tap the slider control and move to the left or right.
- The value to the left of the slider changes.



- Using the numeric keypad: Tap the number to be changed.
- The numeric keypad is displayed (see figure 3).

and configure additional functions as required:



- Tap the additional functions key.
- The "Additional functions" window is shown (see figure 6).

3 Numeric keypad "Time"

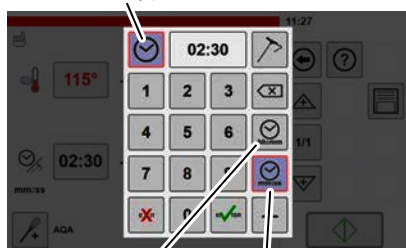

Time selection
"Hours:minutes"

Time selection
"Minutes:seconds"

Changing values with the numeric keypad

- Enter the required value.
- Confirm the value entered with the "Enter" key.
- The numeric keypad closes. The value is saved.

Key legend:



Delete from right to left



Close numeric keypad without saving



Confirm entry and close numeric keypad

4

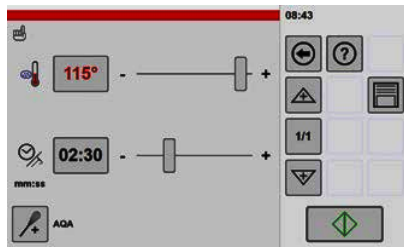

Switching from timed cooking to core temperature

For instructions about using the core temperature sensor, see page 14, section 4.4

There are two ways to select the core temperature function.

1st option – Change over with the "Core temperature" key next to the temperature display:



- Tap the "Time/Core temperature" key.
- The symbol switches to "Core temperature".
- The display switches from time to temperature.

2nd option – Change over with the numeric keypad:



- Tap the "Core temperature" key.
- The key is shaded dark grey and has a border.
- The display switches from time to temperature.

Key legend:



Symbol next to display: Time is activated.



Symbol next to display: Core temperature is activated.



In the numeric keypad: Core temperature (activated = shaded dark grey and has a border)



In the numeric keypad: Time

5

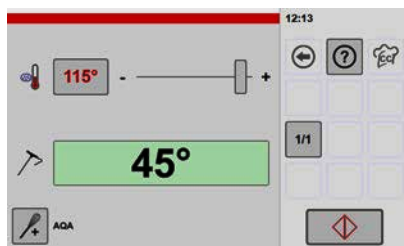

Displaying/changing core temperature setpoint during the cooking process

- During the cooking process, the current temperature of the core temperature sensor is displayed.



- To display or change the core temperature setpoint, tap "Time/Core temperature".
- The numeric keypad with core temperature setpoint is displayed.

6

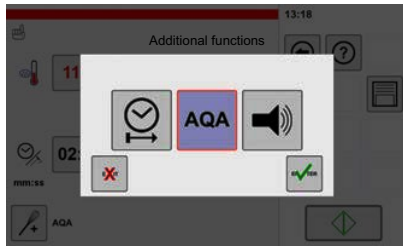

Selecting additional functions

- The "AQA" key is activated permanently and cannot be deactivated.
- ☞ Tap the additional functions you want to use.
 - The key is shaded dark grey and has a border.
- ☞ Use the "Enter" key to confirm the additional functions set.
 - The "Settings" window is shown again.
 - The additional functions set are shown in the window.



Legend for additional functions:



Output signal and message window after cooking step is complete, e.g. for basting, seasoning or turning the food to be cooked. Affects the acoustic signal and external signals.



Start time preselection: Pre-select start of cooking process.
To make settings, refer to the following figure 7

AQA

Automatic Quantity Adjustment (quantity detection and cooking time adjustment). AQA is activated permanently.



Close the additional functions window without confirming changes (cancel).



Confirm settings and close window.

7

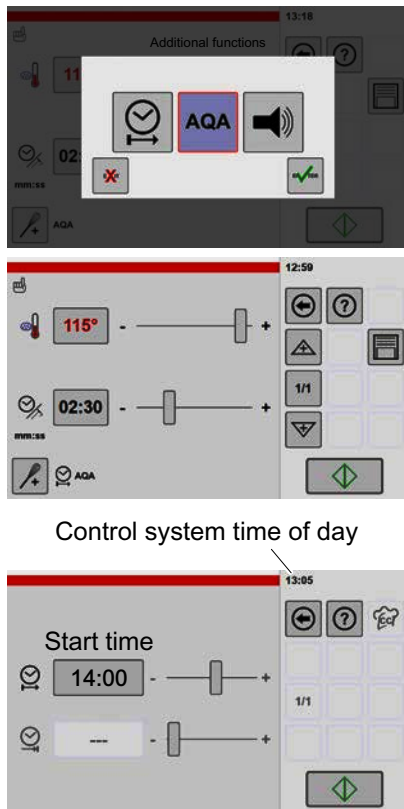

Selecting the additional function "Start time"

The start time can be pre-defined.



- ☞ Tap the "Start time" key.
 - The key is shaded dark grey and has a border.



- ☞ Use the "Enter" key to confirm the additional functions set.



- The "Settings" window is shown again.
- The start time symbol is shown at the bottom left of the window.



- ☞ Tap the "Start/Stop" key.
 - The start time window is shown.



- ☞ Set the time of day when the cooking process should start.
 - Set by using the slider or the numeric keypad.

Sample figure:

- Control system time 13:08
- Start time 14:00



- ☞ Tap the "Start/Stop" key.
 - The progress bar provides a graphical display of the elapsed time.
 - When the configured time of day is reached, automatic quantity adjustment (AQA) takes place and the cooking process then starts.

8

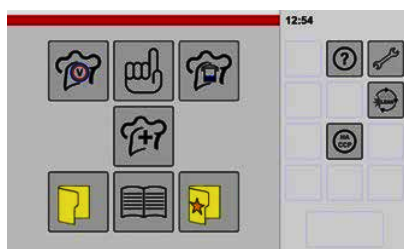

Resetting to start screen



- ☞ Tap and hold the "Back" key for approx. 2 seconds.



- The symbol in the key changes.
- The start screen appears when the key is released.
- All manual settings made previously are reset to their default values.
- Any manually set cooking steps are deleted.

6.2 Adding cooking steps/combinations

Up to 20 cooking steps can be combined. Cookbook option: The cooking steps can be stored in the cookbook (see page 33, section 7.1).

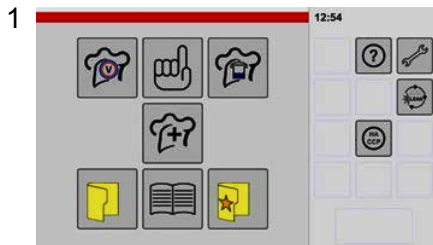

Starting manual settings (1st cooking step)



(Sample figure: feature level Pro with options).

- ☞ Tap the "Manual" key
- The "Settings" window is shown.

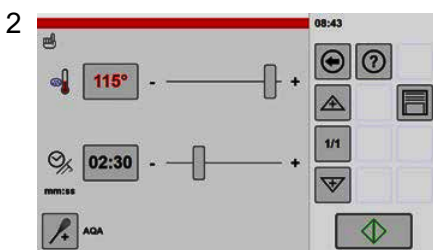

Configure the settings and add the 2nd cooking step

- ☞ Configure the settings, e.g. temperature, time, core temperature, additional functions.



- ☞ Tap the "New cooking step" key.
- The "1/1" display switches to "2/2".

- ☞ Configure the settings, e.g. temperature, time, core temperature, additional functions.

- If you require additional cooking steps, repeat these steps until all of the cooking steps you need have been created.

Key legend:



- Move up or down in the cooking steps (only if several cooking steps have been stored).

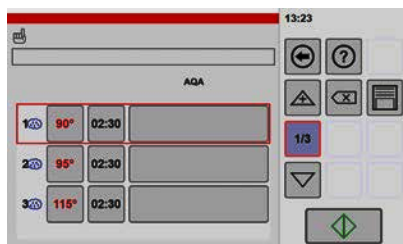

- Inserting a new cooking step **before** the selected cooking step.



- ☞ Tap and hold the "Arrow" key briefly.
- The symbol changes to the "New cooking step" symbol.
- After the key is released, the operating modes window is shown.



- Inserting a new cooking step **after** the selected cooking step:



- ☞ Tap and hold the "Arrow" key briefly.
- The symbol changes to the "New cooking step" symbol.
- After the key is released, the operating modes window is shown.



- Add a new cooking step before or after the cooking step marked.



- Switch to the cooking steps overview.
- For a description, see next figure 3*

3 Tap the value

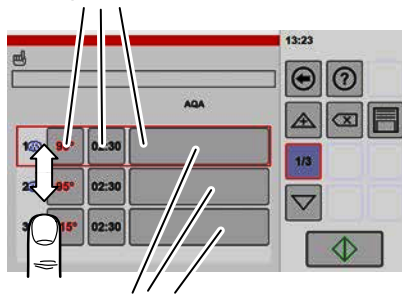

Additional functions:

- Start time preselection
- Automatic Quantity Adjustment

(AQA is activated permanently and cannot be deactivated)

Displaying/changing cooking steps in the overview window



- Tap the "Cooking steps overview" key
- The "Cooking steps overview" window is shown.



If more cooking steps have been created than can be shown on the display screen:

- Tap the screen and use your finger to scroll the cooking steps displayed up or down.



- Each value displayed can be changed by tapping the value.



- After the change has been made, the settings for the current cooking process can be started.



- Cooking steps can be deleted individually (*see next figure 5*).
- If you switch back to the start screen, all cooking steps are deleted.

Appliance type Easy without cookbook option:

- The cooking step settings are stored for the current cooking process only. The settings are not preserved if the appliance is switched off and on again.

Cookbook option:

- If the settings are not stored in the cookbook, they are no longer available after switching the appliance off and on (*For instructions about saving to the cookbook, see page 33, section 7.1*).

4

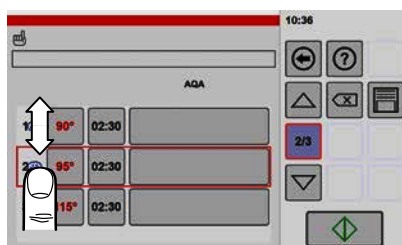

Starting cooking steps – starting any cooking step

By default, cooking steps are processed in sequence. However, cooking can also be started with any step.



- Tap the "Cooking steps overview" key
- The "Cooking steps overview" window is shown.



If more cooking steps have been created than can be shown on the display screen:

- Tap the screen and use your finger to scroll the cooking steps displayed up or down.



- Tap the number of the cooking step that you want to use.
- A border is shown around the cooking step.

- Tap the "Start/Stop" key.

- The symbol in the "Start/Stop" key changes from green to red.
- The cooking process starts with the selected cooking step.

5

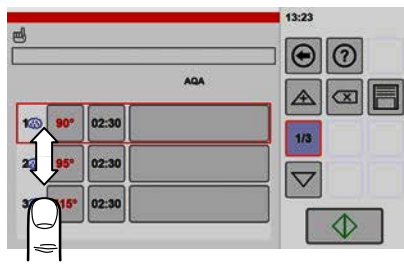

Deleting individual cooking steps in the overview window



- Tap the "Cooking steps overview" key
- The "Cooking steps overview" window is shown.



If more cooking steps have been created than can be shown on the display screen:



- Tap the screen and use your finger to scroll the cooking steps displayed up or down.



- Tap the number of the cooking step that you want to delete.
- A border is shown around the cooking step.



- Tap the "Delete" key.
- The cooking step is deleted.

6

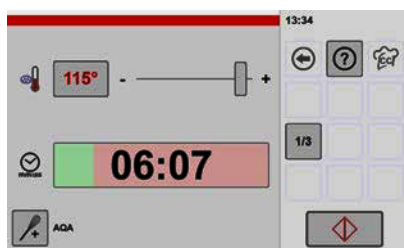

Displaying cooking steps started

- After starting the cooking process, the sum of the cooking times of all cooking steps set is displayed.
- The remaining time is displayed.
- The progress bar provides a graphical display of the elapsed time.
- You can change settings during the cooking process (*see figure 3 in this section.*)
- This combination of cooking steps can be started again after the cooking process has completed.

Important information about additional functions after starting the cooking process

- AQA: the additional AQA function is activated permanently. The quantity/cooking time is adjusted automatically to match the quantity of the product to be cooked. After the quantity/cooking time has been adjusted, the specified cooking time starts.

6.3 Using revitalisation



If this function is activated, the "Revitalisation" key is shown.

To add the "Revitalisation" key to the home screen, see from page 45, section 9. (figure 12).

With these functions, you can prepare the ready-to-serve dishes specifically for à la carte or banquet catering business.

- 1 



Starting revitalisation

 - Tap the "Revitalisation" key.
 - The "Revitalisation" window is shown.
- 2 

Select

 - For example, tap the "Soup" key.
 - The "Settings" window is shown.

Key legend:

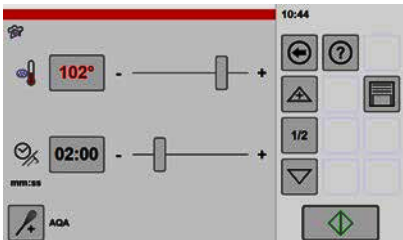
 -  Revitalise foods in containers, e.g. Gastronorm containers
 -  Revitalise soups
 -  Revitalise fish and meat
- 3 

Starting the cooking process

 - Adjust settings as required.
 - Tap the "Start/Stop" key.

6.4 Using cooking methods



If this function is activated, the "Cooking method" key is displayed.

To add the "Cooking method" key to the home screen, see from page 45 , section 9. (figure 12).

Seven pre-set cooking methods are configured for the cooking method feature.

1  **Starting the cooking method**

- Tap the "Cooking method" key.
 - The "Cooking method" window is shown.

2  **Cooking method selection**



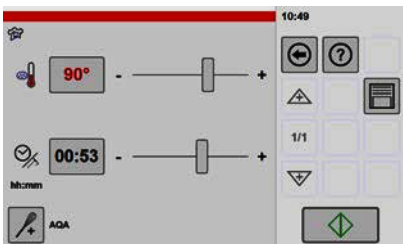



- Tap the cooking method you want to use.
 - The cooking method window is shown with the default values.

 Use the slider or numeric keypad to change the values.

 For instructions on using the numeric keypad, see page 18 , figure 3.

 To start the cooking method, see page 15 , figure 1.

Cooking method legend: (approximate values)

Description	Temperature	Time
 Pressureless cooking	90 °C	15:00 minutes
 Pressure cooking (medium setting)	111 °C	03:00 minutes
 Pressure cooking (highest setting)	119 °C	02:30 minutes
 Defrosting	60 °C	30:00 minutes
 Braising	105 °C	30:00 minutes
 Blanching	105 °C	00:20 seconds
 Revitalise foods in containers, e.g. Gastro-norm containers	106 °C	03:00 minutes

6.5 Using special programs



The "Special programs" key is shown if this option is included with the appliance and activated.

To add the "Special programs" key to the home screen, see from page 45, section 9. (figure 12).

1



Selecting special programs



- Tap the "Special programs" key.
- The "Special programs" window is shown.
- Special programs and cooking methods can also be combined.

2



Selecting programs



- For example, tap the "Delta T cooking" key.
- The "Settings" window is shown.

Legend for special programs:



Delta T cooking

- Suitable for all larger meat joints or roasts.
- Uniform temperature differential between the cooking chamber and core temperature during the cooking process.



Soft cooking

- Program with a final phase at less than 100 °C.



NT – overnight cooking

- Tap the "NT overnight cooking" key. A default setting with several cooking steps is displayed. The help function offers suggestions for products with value settings.
- Observe good hygiene at all times! Bacteria can multiply very quickly in food in the cooking chamber that has not been chilled or heated.

6.6 Using cooking programs from the cookbook



If the appliance is equipped with this option and it is activated, the "Cookbook" key is displayed.
To add the "Cookbook" key to the home screen, see from page 45, section 9. (figure 12).

Products can be entered, changed and deleted in the cookbook (see page 33, section 7.).

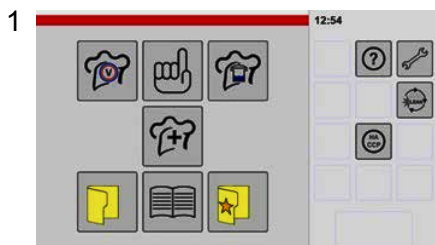

Starting the cookbook



- ☞ Tap the "Cookbook" key.
- The "Cookbook" window is shown.



Scrolling the display



If more products have been created than can be shown on the display screen:

- ☞ Tap the screen and use your finger to scroll the products displayed up or down.



Searching for product names



- The search function can be used in the pictogram or list display.
- ☞ Tap the "Search" key.
- ☞ Enter the search text, e.g. "sch".
- The search is not case-sensitive.
- You do not need to enter a whole word.
- The more precise your search term, the shorter and more compact the results that will be shown.



- ☞ Tap the "Confirm" key.
- All products are displayed that have a word containing the entered characters "sch".



Key legend:



Cancel



Confirm and start search



Switch between keyboard layouts



Move the cursor to the left or right



Delete text from right to left

4



Switch between cookbook views



- Tap the "Change view" key.
 - The display switches to pictogram view.

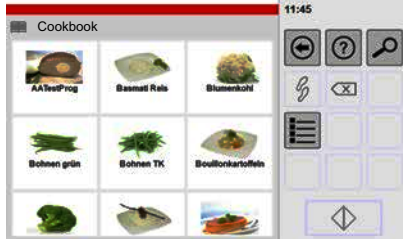

Key legend:



Switch to pictogram view.



Switch to list view.

5



Displaying/changing cooking steps in the overview window

- Tap the product you want.
 - A border is added to the product.
- Tap the "Cooking steps overview" key.
 - The "Cooking steps overview" window is shown.



Tap the value

Key legend:



Display cooking steps overview.



- Each value displayed can be changed by tapping the value.



- After the change has been made, the settings for the current cooking process can be started.



- If the settings are not stored in the cookbook, they are no longer available after switching the appliance off and on (*For instructions about saving to the cookbook, see page 33, section 7.1.*)

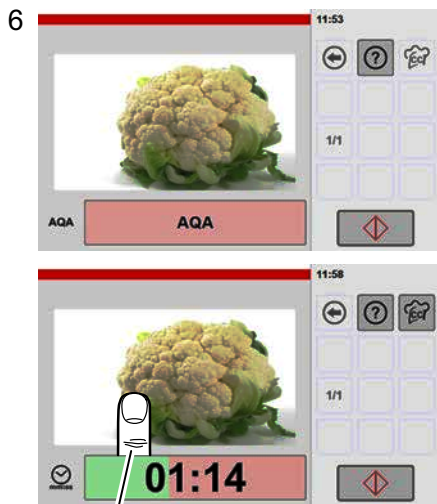

Changing settings during an active cooking process: tap the screen – the "Settings" window is shown for approx. 5 seconds.

Cooking process window – cooking process started

- AQA: The quantity/cooking time is adjusted automatically. The automatic quantity/cooking time adjustment is permanently set and cannot be deactivated.
- After AQA is complete: the remaining time is displayed.
- The progress bar provides a graphical display of the elapsed time.
- The cooking process can be interrupted by tapping the "Start/Stop" key.

For the "End of cooking process" description, see from page 16 from section 4.5.2

6.7 Working with categories (menu groups)



This function is a part of the cookbook.

For instructions about creating or deleting categories, see page 39, section 7.4.

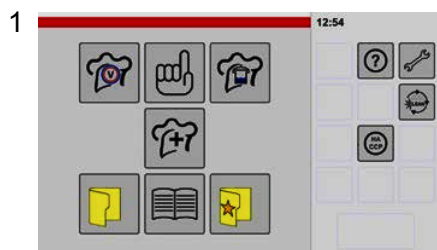

Starting categories



- Tap the "Category" key.
- The "Categories" (product groups) list is displayed.



Scrolling the display



- If more categories have been created than can be shown on the display screen:
- Tap the screen and use your finger to scroll the products displayed up or down.



Selecting categories



- Tap the category you want.
- A border is added to the selected category.
- Tap the "Enter" key.
- The category content is displayed.

Key legend:



- Confirm the selected category.

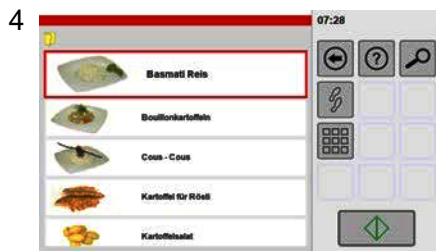

Selecting a product

- ☞ Scroll the display by tapping and moving up or down.
- ☞ Tap the product you want.
 - A border is added to the selected product.



- ☞ Tap the "Start/Stop" key.
 - The cooking process starts.
 - The "Cooking process" window is shown.
 - The symbol in the "Start/Stop" key changes from green to red.

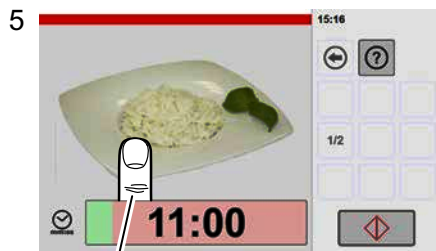

Cooking process window

- Automatic quantity/cooking time adjustment (AQA display) is performed before the cooking time starts.
- After AQA completes, the remaining time is shown.
- The progress bar provides a graphical display of the elapsed time.
- The cooking process can be interrupted by tapping the "Start/Stop" key.

Changing settings during an active cooking process: tap the screen – the "Settings" window is shown for approx. 5 seconds.

6.8 Working with favourites (preferred products)



This function is a part of the cookbook.

Favourites need to be assigned before you can use them.

For instructions about assigning products to favourites, see from page 33 , section 7.1 (figure 6).



Starting favourites



- ☞ Tap the "Favourites" key.
 - The "Favourites" window is shown.

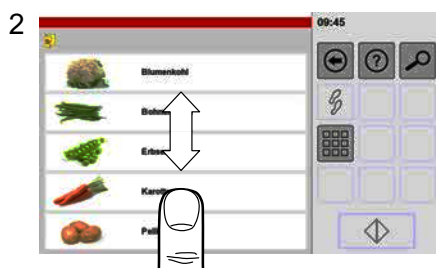

Scrolling the display



If more products have been created than can be shown on the display screen:



- ☞ Tap the screen and use your finger to scroll the products displayed up or down.

3



Selecting a product

- ☞ Tap the product you want.
 - A border is added to the product.
- ☞ Tap the "Start/Stop" key.
 - The cooking process starts.
 - The "Cooking process" window is shown.
 - The symbol in the "Start/Stop" key changes from green to red.

4

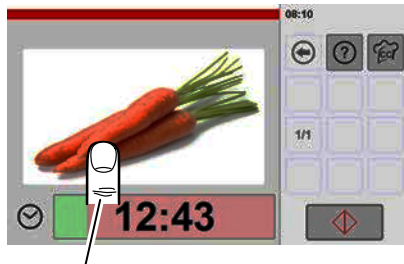

Cooking process window

Changing settings during an active cooking process: tap the screen – the "Settings" window is shown for approx. 5 seconds.

- Automatic quantity/cooking time adjustment (AQA display) is performed before the cooking time starts.
- After AQA completes, the remaining time is shown.
- The progress bar provides a graphical display of the elapsed time.
- The cooking process can be interrupted by tapping the "Start/Stop" key.

7. Creating, changing and deleting cookbook products

This function is a part of the cookbook.

7.1 Creating, saving and assigning products



Up to 20 cooking steps can be combined.



1

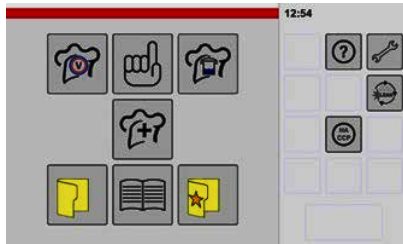

Starting manual settings



- Tap the "Manual" key
- The "Operating Modes" window is shown.

2

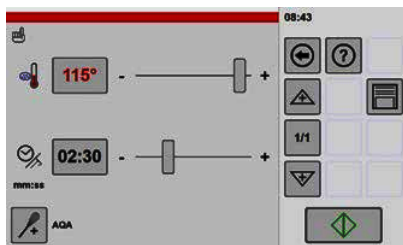

Configuring settings

- Configure the settings, e.g. temperature, time, core temperature, additional functions.

If additional cooking steps need to be created, see the following figure 3.

If you want to save now, refer to the following figure 4.

3

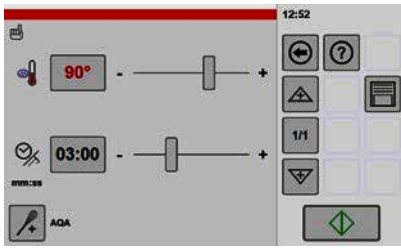

Adding a cooking step



- ☞ Tap the "New cooking step" key.
 - The "Settings" window is shown.
 - The "1/1" display switches to "2/2".
- ☞ Configure the settings, e.g. temperature, time, core temperature, additional functions.
 - If you require additional cooking steps, repeat this step until you have created all the cooking steps you need. Up to 20 cooking steps can be created.

Key legend:



Move up in the cooking steps (only if several cooking steps are stored).



Move down in the cooking steps (only if several cooking steps are stored).



Inserting a new cooking step **before** the selected cooking step.



- ☞ Tap and hold the "Arrow" key briefly.
 - The "New cooking step" key symbol is shown.
 - The "Operating Modes" window is shown.



Inserting a new cooking step **after** the selected cooking step:



- ☞ Tap and hold the "Arrow" key briefly.
 - The "New cooking step" key symbol is shown.
 - The "Operating Modes" window is shown.



Add a new cooking step before or after the cooking step marked.



Switch to the cooking steps overview.

4



Opening the window for the save process



- ☞ Tap the "Save" key.
 - The "Product entry" window is shown.
 - The value defaults to the next available number.
- ☞ Enter the number you want.
- ☞ Enter the name you want.

Key legend:



Switch between keyboard layouts.



Move the cursor to the left or right.



Delete text from right to left.

5

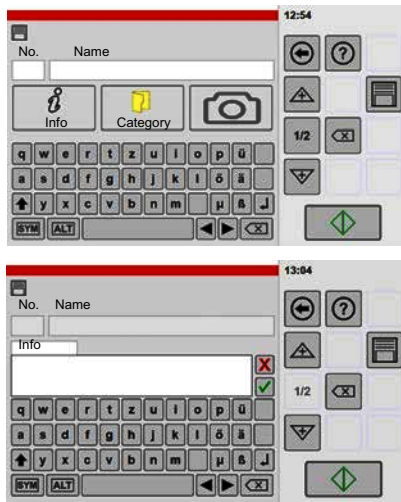

Add an information item

You can enter any additional information here.



Tap the "Info" key.

- A box for entering text is displayed.

Enter the text you want.



Tap the "Confirm" key.

Key legend:



Confirm



Cancel

6

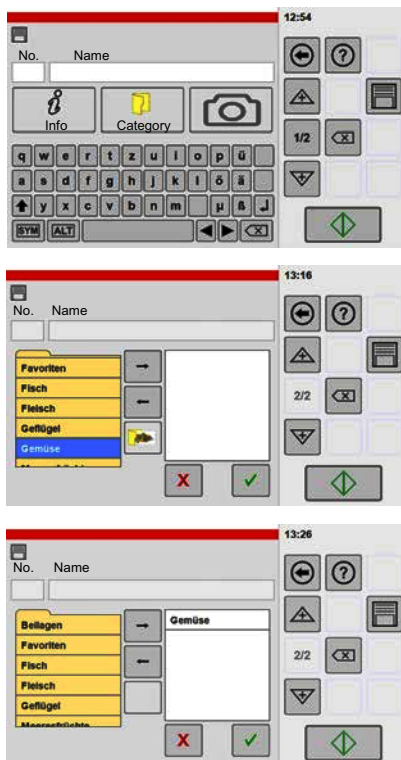

Assign to categories and favourites



Tap the "Categories" key.

Tap the category you want, e.g. vegetables or "Favourites".

- A border is shown around the category or "Favourites".



Tap the "Arrow" key.

- The selected category or "Favourites" is moved from the left into the panel on the right.
- The product is now assigned to the selected category (e.g. vegetables) or "Favourites".
- A product can be assigned to several categories. To do so, repeat this procedure for each individual category.



Tap the "Confirm" key.

Key legend:



Add categories and favourites



Remove categories and favourites



Cancel



Confirm

7



Adding an image

Images for meals have been created as factory defaults.

If you would like to use your own images, you must first import them into appliance storage.

For instructions about importing digital photos, see page 55, figure 17



Tap the "Camera" key.

- An overview of the images stored in the system is shown.

Scroll the display as necessary.

Tap the image you want.

- The image is shown with a border.



Tap the "Add" key.

- The image is shown above the add key.



Tap the "Enter" key.

- The image is now assigned and the "Product entry" window is shown.

Key legend:



Add the selected image.



Confirm

8



Removing an image



Tap the key with the image to be deleted.

- An overview of the images stored in the system is shown.

Scroll up the images shown until the "Camera" icon is shown at the end.



Tap the "Camera" key.

- A border is shown around the camera.



Tap the "Add" key.

- The image is displayed above the add key.



Tap the "Enter" key.

- The image is now assigned and the "Product entry" window is shown.

Key legend:



Add the selected image.



Confirm



Remove the image and assign the symbol.

9

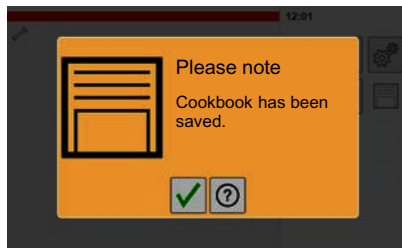

Saving the settings



Tap the "Save" key.

- The product is saved in the cookbook and assigned to the selected category or favourites.
- The window for confirming the save process is shown.



Tap the "Confirm" key.

- The save process is completed.
- The product can now be accessed from the cookbook, in the assigned category or in the favourites.

Key legend:



Save to cookbook



Confirm the save process

7.2 Changing settings for products in the cookbook



All of the settings stored in the cookbook can be adjusted or changed, e.g.: temperatures, times, favourite assignments, category assignments, cooking steps, etc.

1



Opening the cookbook



Tap the "Cookbook" key.

- The "Cookbook" window is shown.

2



Selecting the product

Tap the product you want.

- A border is added to the product.



Tap the "Cooking steps" key.

- The "Settings" window is shown.

3



Tap the value

Displaying/changing the cooking steps



Tap the "Cooking steps overview" key.

- The "Cooking steps overview" window is shown.

If more cooking steps have been created than can be shown on the display screen:

Tap the screen and use your finger to scroll the cooking steps displayed up or down.



- Each value displayed can be changed by tapping the value.

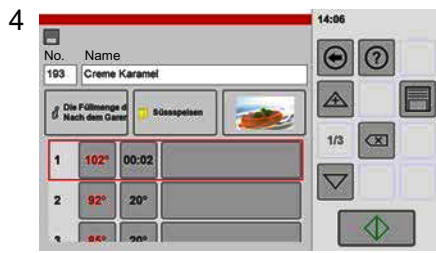

Changing the settings

You can make changes here to the number, name, info, category/favourites and image.

For a more detailed description, see page 34 from figure 4.



- ☞ Tap the "Save" key.
- The changes are saved to the cookbook.
- The window for confirming the save process is shown.

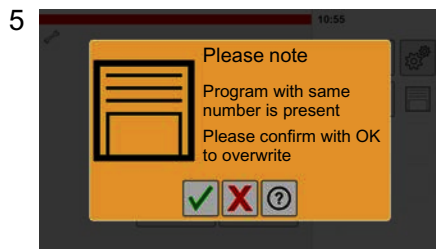

Confirming the save process



- ☞ Tap the "Confirm" key.
- The save process is completed.
- The product has been changed.

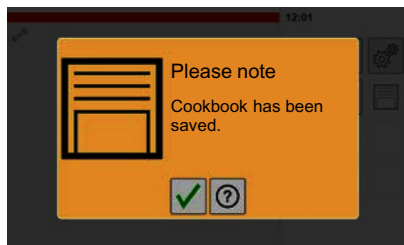

- ☞ Tap the "Confirm" key.
- The save process is completed.

7.3 Deleting a product from the cookbook



Opening the cookbook



- ☞ Tap the "Cookbook" key.
- The "Cookbook" window is shown.



Selecting and deleting a product

- Tap the product to be deleted.
 - A border is added to the product.



- Tap the "Delete" key.
 - A confirmation dialog is shown.

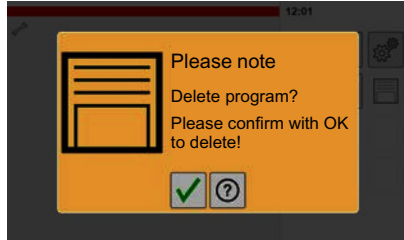

- Tap the "Confirm" key.
 - The window for confirming the save process is shown.

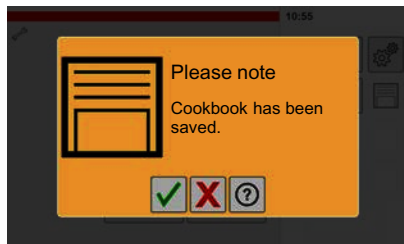

- Tap the "Confirm" key.
 - The save process is completed.
 - The product has been deleted.

7.4 Creating and deleting categories

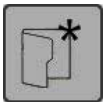

This function is a part of the cookbook.

7.4.1 Creating categories

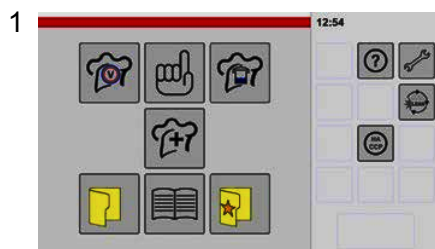

Starting categories



- Tap the "Category" key.
 - The "Categories" (product groups) list is displayed.

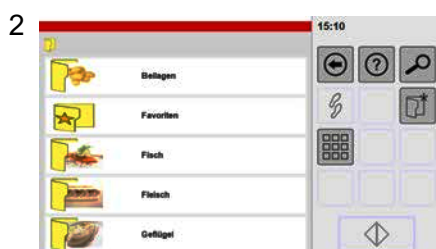

Creating a new category



- Tap the "New category" key.
 - An input window is shown.



Entering the name

☞ Enter a name for the category.



☞ Tap the "Enter" key.

- An overview of the images stored in the system is shown.

Key legend:



Switch between keyboard layouts.



Move the cursor to the left or right.



Delete text from right to left.



Confirm



Cancel

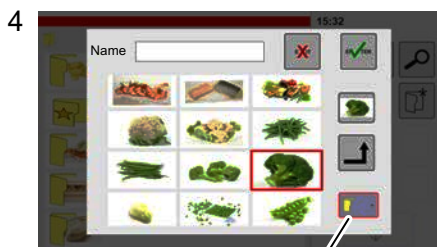

Switch category symbol on/off

Adding an image

☞ Scroll the display by tapping and moving up or down.

☞ Tap an image.

- A border is shown around the selected image.



☞ Tap the "Add" key.

- The image is shown above the add key.



☞ Tap the "Enter" key.

- The window for confirming the save process is shown.

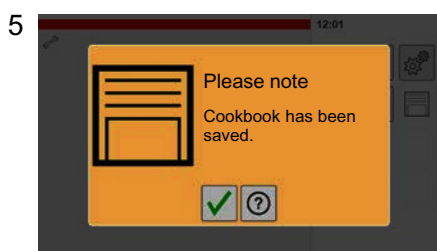

Saving



☞ Tap the "Confirm" key.

- The category has been saved in the cookbook.

For instructions about assigning products to a category, see from page 33 , section 7.1 , figure 6.

7.4.2 Deleting categories with products

Categories can be deleted only if they have no assigned products.

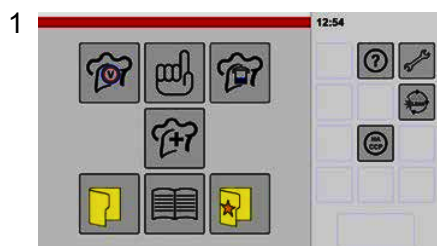

Starting categories



☞ Tap the "Category" key.

- The "Categories" (product groups) list is displayed.



Selecting categories

- Tap the category to be deleted.
 - The category is shown with a border.
 - The "Delete" key is active only when there are no more products in the category.



- Tap the "Confirm" key.
 - The products assigned to this category are displayed.



Selecting a product

- Tap a product.
 - A border is added to the product.



- Tap the "Cooking steps" key.
 - The "Settings" window is shown.

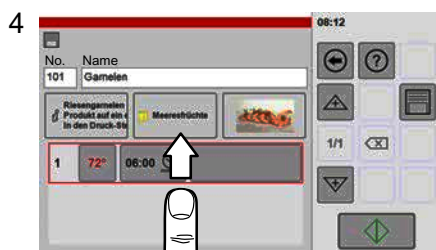

Opening the categories/favourites window

- Tap the "Category/Favourites" key.
 - The assignment window is shown.

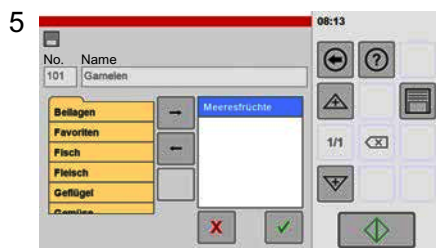

Selecting and removing a category

- Tap the category to which the product is assigned.
 - The selected category is marked.



- Tap the "Arrow" key.
 - The category is removed from the window and so is no longer assigned to the product.

Category is removed

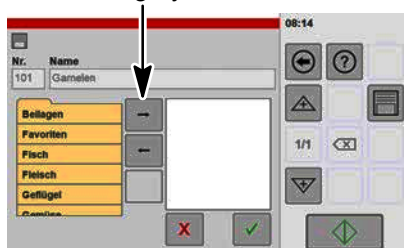

- Tap the "Confirm" key.
 - The "Settings" window is shown.
 - The category is removed from the display.



- Tap the "Save" key.
 - The window for confirming the save process is shown.

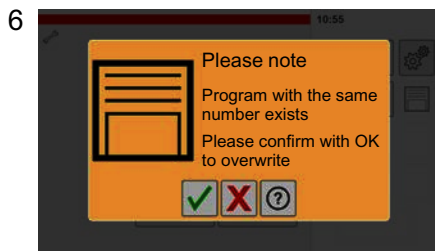

Saving the change



- ☞ Tap the "Confirm" key.
 - The category assignment in the cookbook is deleted.
 - The window for confirming the save process is shown.



- ☞ Tap the "Confirm" key.
 - The save process is completed.
 All products must be removed from the category.

To remove other products from the category:



- ☞ Tap the "Back" key.
 - To repeat the process, see from figure 3 (page 41).

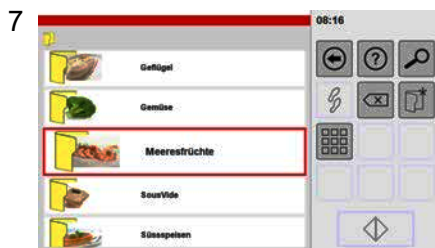

Deleting a category

- The "Delete" key is active once all category assignments have been deleted.
- ☞ Tap the category to be deleted.
 - A border is added to the selected category.



- ☞ Tap the "Delete" key.
 - The window for confirming the save process is shown.

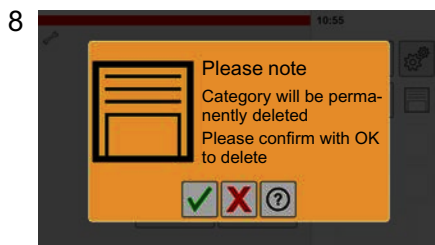

Applying the deletion



- ☞ Tap the "Confirm" key.
 - The category will be deleted.
 - The window for confirming the save process is shown.

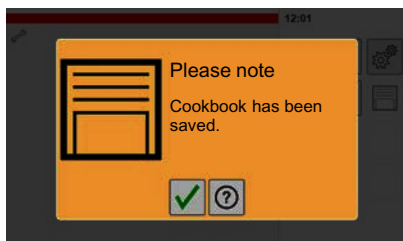

- ☞ Tap the "Confirm" key.
 - The save process is completed.
 - The category has been deleted.

8. Displaying and exporting HACCP logs



HACCP is an abbreviation for Hazard Analysis Critical Control Points

- The HACCP log is required in order to audit process flows.
- These logs are an important tool for process owners and help them to prove that they have fulfilled their duties of care.
- HACCP logs are kept for 60 days. Once this 60-day period has elapsed, the logs are automatically deleted.

For instructions on configuring output data for HACCP logs, see page 55 , figure 16.

For instructions on exporting data, see page 55 , figure 18.

8.1 Displaying HACCP logs



1 Displaying HACCP logs



- ☞ Tap the "HACCP" key.
- The "HACCP" window is shown.

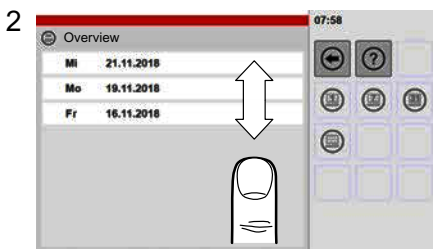

2 Scrolling the display



- If more logs are available than can be shown on the display screen:
- ☞ Tap the screen and use your finger to scroll the logs displayed up or down.
- ☞ Tap the date you want.
 - The selection is shown with a border.

Key legend:



Displaying a selected day log



Active for appliances with USB activation.
For instructions on exporting day data, see page 44 , section 8.2



Active for appliances with USB activation.
For instructions on exporting week data, see page 44 , section 8.2



Active for appliances with USB activation.
For instructions on exporting month data, see page 44 , section 8.2

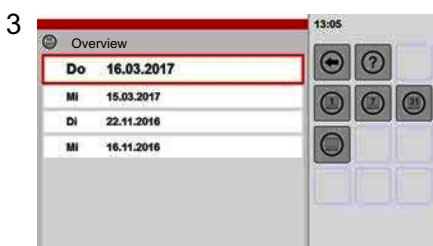

3 Selecting a day



- ☞ Tap the date you want.
 - The selection is shown with a border.
- ☞ Tap the "Details" key.
 - Data is displayed.

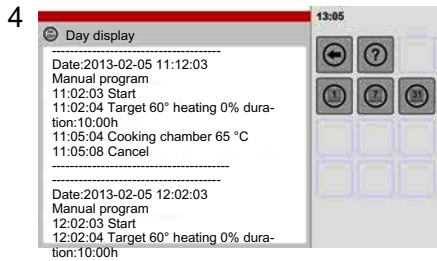

Scrolling the display

If more data is available than can be shown on the display screen:

- Tap the screen and use your finger to scroll the display up or down.

8.2 Exporting HACCP logs to a USB drive

⇒ For USB flash drive requirements, see page 57 section 10.1



Starting HACCP logs



- Tap the "HACCP" key.
- The "HACCP" window is shown.

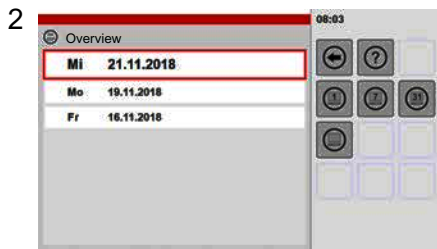

Selecting an export date



Day

- Tap the date to use as the end date (data is exported backwards from this date).
- The selection is shown with a border.



Week

- Tap the "Day/week or month data" key.
- The data is written to the USB drive.



Month

- If identical filenames exist on the USB drive, these files will be overwritten without warning.
- A message is shown after the data has been written.

 Appliance number: 999004
 Appliance type: E101SCRNFBUW
 Operating hours:
 Printout date: 06.02.12 10:05:48
 KT every 180s

 Date: 2012-02-05
 Time: 22:02

 Date:2012-02-05 22:02:03
 Manual program
 22:02:03 Start
 22:02:04 Target 60° heating 0% duration:10:00h
 22:05:04 Cooking chamber 65 °C
 22:05:08 Cancel



- Tap the "Confirm" key.
- Remove the USB drive.

Information about data exported to the USB drive:

- A folder is created with the appliance serial number.
- The filename includes the date of the export.
- The file includes the appliance and cooking data (*see example shown on left*).

9. Configuring the control system and user interface



All of the possible settings are shown in the following figures. Depending on equipped appliance features, several setting options will be non-functional, e.g. greyed-out and not available for selection or the window is not shown on the control panel.



Starting screen settings/setup



If the "Setup" icon is not shown, tap and hold the "Back" key briefly.



- The key display changes from "Back key" to "Home".
- The start screen is shown when you release the key.



Tap the "Settings/Setup" key.

- The "Appliance data" window is shown.

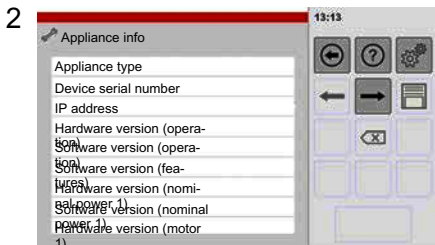

Displaying appliance data

Here you can read appliance data such as the version number, installed options and free (flash) memory.



To view all of the information, touch the display panel and scroll the list up and down.



Continue to the next window – tap the arrow key.

- If a PIN (Personal Identification Number) has been enabled, you cannot move to the next window. Instead, the PIN entry window appears.

For information about entering or deleting the PIN, see figure 9 and 10 in this section.

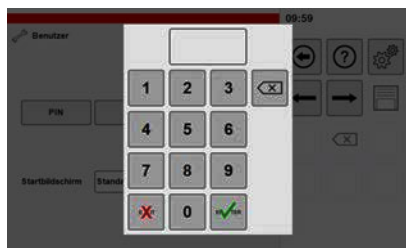

Key legend:



Reset to start screen



Access help system



Only selectable by authorised customer service



Step through the windows shown



Save the setting



Reset the settings



Note on progress bar:
shown while saving, exporting, importing (for example)

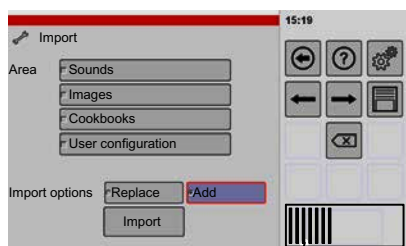

Progress bar

3

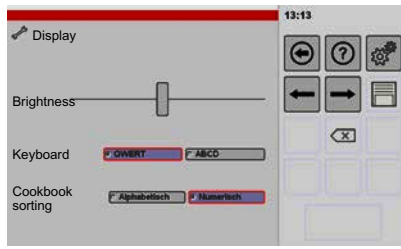

Configuring the display for

- Screen brightness
- Keyboard layout
- Cookbook sort order



☞ Setting screen brightness – tap the slider and move to the left or right.
 - Left = dark, right = bright

☞ Setting the keyboard layout – tap the layout you want to use.
 - QWERT = typewriter/computer keyboard
 - ABCD = alphabetic keyboard layout

☞ Setting the cookbook sort order – tap the order you want to use.
 - Alphabetic
 - Numeric

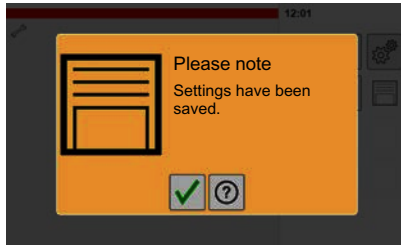

☞ Tap the "Save" key.
 • A message about the save process is displayed.



☞ Tap the "Confirm" key.
 • The message disappears.



☞ Continue to the next window – tap the arrow key.

4

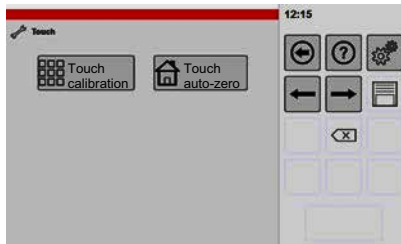

Automatic screen sensitivity adjustment

Caution! Do not touch the user interface for 10 seconds during automatic sensitivity adjustment, otherwise tapping the interface may cause malfunctions.



☞ Tap the "Touch auto-zero" key.
 • A message appears.
 • The sensitivity is adjusted automatically.
 • Sensitivity adjustment is complete when the message disappears.



☞ Continue to the next window – tap the arrow key.

5

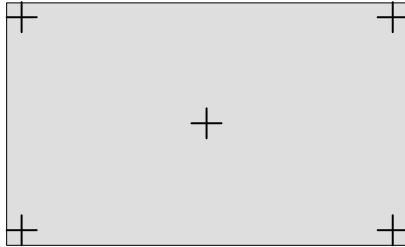
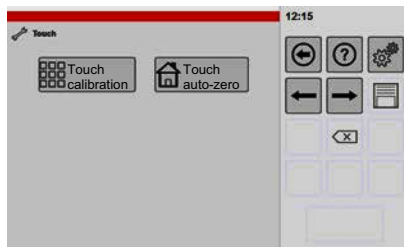

Calibrating/aligning the display

Caution! Incorrect calibration will mean that the touch screen no longer responds to taps as input! If this happens, the calibration process must be carried out by using a PC mouse. To do so, connect the PC mouse to the USB port and follow the on-screen instructions by moving the mouse cursor. A connected PC mouse is recognised only after restarting the appliance.



Tap the "Touch calibration" key.

- A window with crosshairs in the centre is shown.
- **IMPORTANT:** only tap the crosshairs. Do not tap anywhere else otherwise malfunctions may occur.

Tap the crosshairs.

- The crosshairs now change position to the bottom right corner.

Tap the crosshairs.

- The crosshairs move to the next corner.

Continue tapping the crosshairs until all corners are confirmed.

- A message about the save process is displayed.



Tap the "Confirm" key.

- The message disappears.
- Calibration is now complete.



Continue to the next window – tap the arrow key.

6

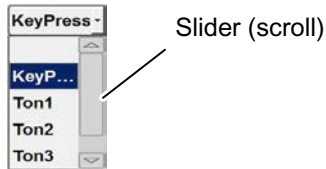
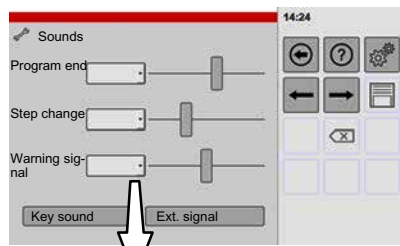

Setting the acoustic signals (tones)

Several sound files are included as a factory default. These can be used variously for a range of different messages.



- ☞ Turn the volume up so that a selected sound can be heard when a sound file is opened.
- Slider control: left quiet – right loud.



- ☞ Tap the arrow key.
- The available files are displayed.



- A scrollbar will be shown if there are a large number of files available.

- ☞ Tap the arrows or the scrollbar and scroll until the file you want is visible.

- ☞ Tap your chosen selection.
- An acoustic signal sounds.



- ☞ Tap the "Save" key.
- A message about the save process is displayed.



- ☞ Tap the "Confirm" key.
- The message disappears.



- ☞ Continue to the next window – tap the arrow key.

Information about settings options:

Program end: signal sounds at the end of the cooking process.

Step change: In cooking programs with different operating modes, a signal sounds before switching to the next mode.

Warning signal: when messages with a red or yellow background appear on screen.

Combi-cooking insertion time: signal sounds when an insertion time expires.

Key sound: sound played when tapping keys.

External signal: External speaker or a lamp external to the device (must be installed on-site by the customer).

7

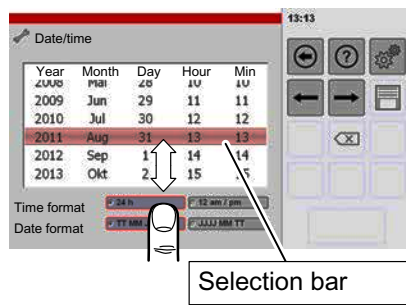

Setting the date and time

- These values are arranged in columns.
- ☞ Tap the column to be changed and scroll until the value you want appears in the selection bar.
- ☞ Time format – tap the value you want.
 - 24 h
 - 12 am/pm
- ☞ Date format – tap the format you want.
 - Day-Month-Year
 - Year-Month-Day
- ☞ Tap the "Save" key.
 - A message about the save process is displayed.
- ☞ Tap the "Confirm" key.
 - The message disappears.
- ☞ Continue to the next window – tap the arrow key.

8

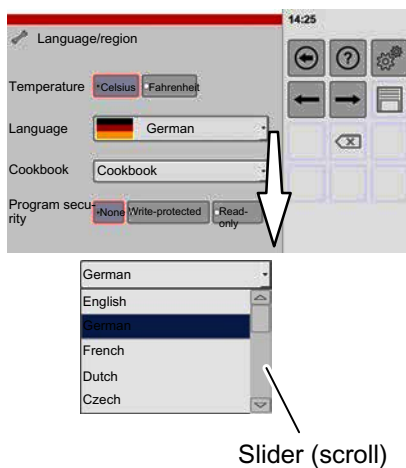

Adjusting the language/region and program security

- ☞ Tap the arrow key (e.g. language or cookbook).
 - The available files are displayed.
 - A scrollbar will be shown if there are a large number of files available.
- ☞ Tap the arrow or the scrollbar and scroll until the file you want is visible.
- ☞ Tap your chosen selection.
 - An acoustic signal sounds.
- ☞ Tap the "Save" key.
 - A message about the save process is displayed.
- ☞ Tap the "Confirm" key.
 - The message disappears.
- ☞ Continue to the next window – tap the arrow key.

Information about settings options:

- Temperature in Celsius or Fahrenheit
- Language: language setting for the control/display panel
- Cookbook: cookbook selection
- Program security for cookbook
 - **None:** changes and additions to the cookbook are possible.
 - **Write-protected:** settings can only be made for the current cooking process. The settings cannot be saved.
 - **Read-only:** The cookbook can be used. However, no settings can be changed for the current cooking process.

9

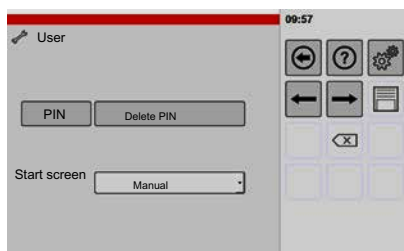

Enabling the PIN/restricting modification permissions

If you want to allow only certain people to change settings, you can block access by entering a PIN.

No PIN (Personal Identification Number) is set as a factory default.

If you have forgotten the PIN you entered, this can only be deleted by the authorised Customer Service.

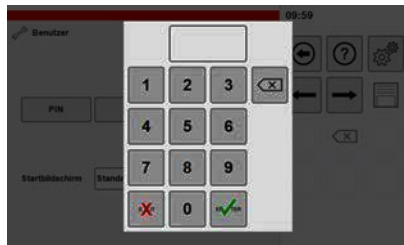

- PIN**
- ☞ Tap the "PIN" key.
 - The numeric keypad is displayed.
 - ☞ Enter a 4-digit PIN.
 - ☞ Tap the "Enter" key.
 - You are prompted to enter the same PIN a second time.

PIN ☞ Enter your PIN again.

☞ Tap the "Enter" key.

☞ Tap the "Save" key.

- A message about the save process is displayed.

☞ Tap the "Confirm" key.

- The message disappears.

☞ You can now continue to the next window.

10

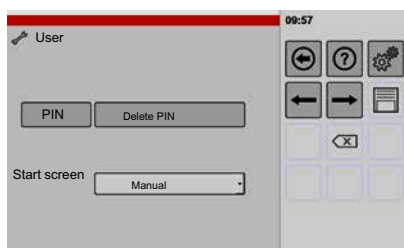

Deactivating/deleting the PIN

This function is used to delete a previously saved PIN. The delete process is necessary, for example, if a new PIN should be created or the restriction of modification permissions is to be lifted.



- Delete PIN**
- ☞ Tap the "Delete PIN" key.
 - The "Save" key changes from light grey to black.
 - If no PIN has been created, the light grey colour of the "Save" key does not change.

☞ Tap the "Save" key.

- A message about the save process is displayed.

☞ Tap the "Confirm" key.

- The message disappears.
- The restrictions have now been lifted.

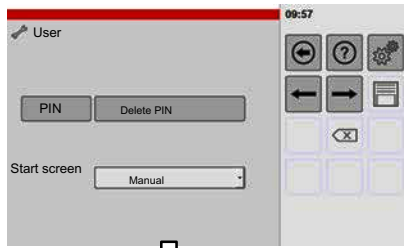

Example display:
"Manual" mode

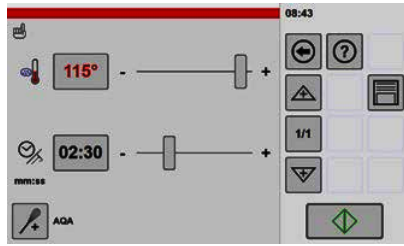

Setting the start screen

This setting can be used to specify the display that should be shown after the appliance is turned on.



- ☞ Tap the box or arrow key.
- The available display options are shown.



- ☞ Tap the arrows or the scrollbar and scroll until the selection you want is visible.
- ☞ Tap your chosen selection.
- The selection is shown in the box.



- ☞ Tap the "Save" key.
- A message about the save process is displayed.
- The selected display is saved and will be shown the next time the appliance is restarted.



- ☞ Tap the "Confirm" key.
- The message disappears.



- ☞ Tap the key to continue to the next window.

Legend for selection options:

Figure 12 Standard = the display is shown as selected in the following figure 12 .

Figure 11 Manual – the operating modes are displayed after switching on.



The cookbook contents are displayed after switching on.



The categories created are displayed after switching on.



The favourites created are displayed after switching on.



The cooking methods are displayed after switching on.



The symbols for revitalising are displayed after switching on.

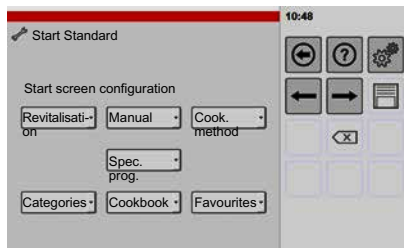

This selection results in the following screen



Setting up the home screen/allocating and arranging functions on the display window

This setting can be used to specify the functions that should be displayed in the display area and their on-screen position.

The pre-sets configured here are displayed when the home key is tapped.



Tap the box or arrow key.

- The available display options are shown.



Tap the arrows or the scrollbar and scroll until the selection you want is visible.

Tap your chosen selection.

- The selection is shown in the box.



Tap the "Save" key.

- A message about the save process is displayed.



Tap the "Confirm" key.

- The message disappears.



Tap the key to continue to the next window.

Legend for selection options:

Empty = nothing is displayed



Manual – this symbol is displayed.



Cookbook – this symbol is displayed.



Categories – this symbol is displayed.



Favourites – this symbol is displayed.



Cooking method – this symbol is displayed.



Revitalisation – this symbol is displayed.



Special programs – this symbol is displayed.

13

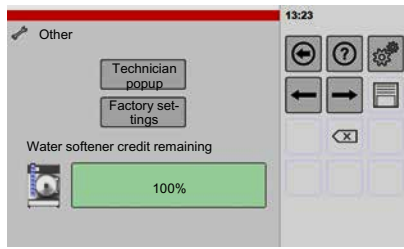

Resetting to factory settings

Settings that have been made by the user, such as the cook-book and user settings, will be reset. As a precaution, save the user settings to a USB drive first. *For instructions about data export, see page 55, figure 18.*

☞ Tap the "Factory settings" key.

- A warning message is shown.



☞ Tap the "Confirm" or "Cancel" key.



☞ Wait until the message disappears, and you are prompted to switch the appliance off and on.



☞ Turn the appliance off and on.

- Wait approximately 30 seconds between switching the appliance off and on.

Information about other setting options:

Technician popup: Refer to the following figure 14.

14

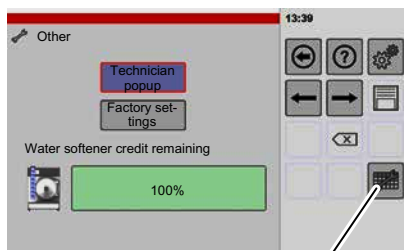

"Technician popup" key

Activating the "Technician popup" function

Expired appliance activities are shown in the "Technician popup" window. This screen can be used for troubleshooting.

The "Technician popup" key must be activated in order to be able to show and hide the technician popup during operation.

The "Technician popup" key is deactivated after switching the appliance off and on again.

Technician popup

Activating the "Technician popup" key

- ☞ Tap the "Technician popup" switch.
- The "Technician popup" key is displayed.



Showing the "Technician popup"

- ☞ Tap the "Technician popup" key.
- The "Technician popup" window is displayed.
- The current appliance status is displayed.

Refreshing the display

- ☞ Tap the "Refresh" key.
- Appliance statuses are updated in the "Technician popup".
- For real-time updates, tap and hold the "Refresh" key.



Hiding the "Technician popup"

- ☞ Tap the "Technician popup" key or anywhere next to it.
- The popup disappears when you tap the "Technician popup" key.
- If you tap anywhere next to the "Technician popup", the "Technician popup" is sent to the background. To bring the popup into the foreground, tap the "Technician popup" key twice.

15



Switching the pull-out shower head on/off

If the pull-out shower head is leaking, it can be switched off with this function.

- ☞ Tap the "Pull-out shower head" key.
- If shown with a red border, this means the shower head is switched on.
- ☞ Tap the "Save" key.
- A message about the save process is displayed.

16 Configuring the HACCP logs

HACCP is an abbreviation for Hazard Analysis Critical Control Points

HACCP logs are kept for 60 days. Once this 60-day period has elapsed, the logs are automatically deleted.

For instructions on exporting data, see page 55 , figure 18.

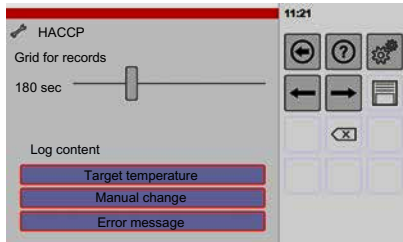

☞ Setting the grid in seconds for records – tap the slider and move to the left or right.

- The value set is displayed in seconds.

☞ Tap the additional save type required.

- The selected save type is highlighted in colour and shown with a border.



☞ Tap the "Save" key.

- A message about the save process is displayed.



☞ Tap the "Confirm" key.

- The message disappears.



☞ Tap the key to continue to the next window.

Information about additional selection options

Log content:

- Target temperature
- Manual changes
- Error messages

17

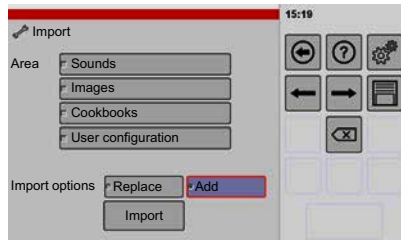

Data import – USB drive -> control system

You can use this function to add cookbooks or image/sound files, for example.

Exporting and importing data , see page 57 , section 10. "Importing" 10.5

18



Data export – control system -> USB drive

You can use this function to save your settings, for example. You can use the saved data to restore user settings, image/sound files and cookbooks, for example.

Exporting and importing data , see page 57 , section 10. "Exporting" 10.4

19

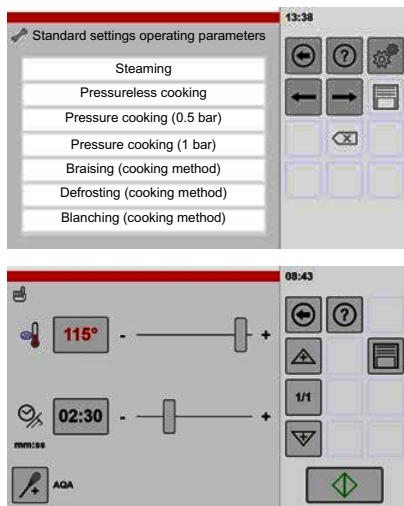

Setting standard cooking data

This screen lets you adjust cooking data to your own operational circumstances. This data is then shown after the relevant operating mode, cooking method or special program is selected.



☞ To view all of the setting options, touch the display panel and scroll the list up and down.

☞ Tap the setting option you want to use.

- The "Settings" window is shown.

☞ Configure the standard cooking data as required.



☞ Tap the "Save" key.

- A message about the save process is displayed.



☞ Tap the "Confirm" key.

- The message disappears.

Information about operating modes/cooking methods/special programs

These include steaming pressureless cooking, pressure cooking, braising, defrosting, blanching, revitalising, Delta-T/NT cooking, soft cooking.

20



Input screen for remote maintenance (optional)

This function is to be used by authorised customer service personnel only.

By entering the relevant data, a remote connection to the factory can be initiated if remote maintenance is required.

To do so, the appliance must be connected with a network cable to a router with an internet connection.

10. Exporting and importing data

This function allows you to save appliance data, add cookbooks or image/sound files or standardise your cookbooks across all your appliances, for example.

Important: always save appliance data before an import (data export)

- A data export gives you the data in the data structure required
 - See next section for the data structure 10.2
 - Exporting data – save data example , see page 60 , section 10.4
- You can modify the exported data according to your requirements and reuse the data for a data import.

10.1 USB data storage media requirements (USB drive)

(USB drive = removable storage device, USB = Universal Serial Bus)

Formatting:

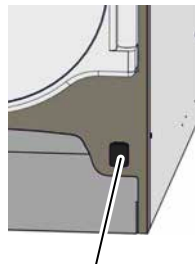
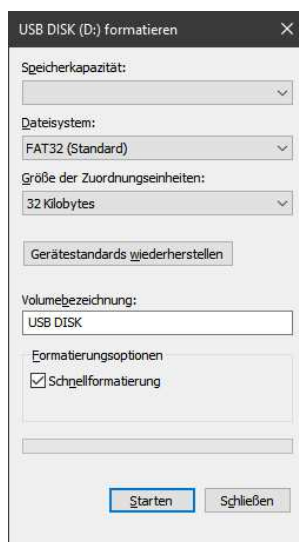

Cover on USB port

The USB drive must support USB 2.0.

Up to 64 GB

- Formatting the USB drive:
File system = FAT32/FAT32 (standard)
- Size of allocation units = 32 kB

64 GB and higher

- Formatting the USB drive:
File system = exFAT
- Size of allocation units = 128 kB

Info

The USB drive can already have data on it. A new directory is created during the export process.

10.2 Data export: Information about the data structure on the USB drive

- Depending on the relevant number of selected areas, for example cookbooks, sounds or images, only the corresponding folders for these areas – e.g. "cookbooks", "pictograms", "sounds" – are copied to the USB drive.
- Filenames must not contain any special characters such as "/", "*", etc.

Folder	Folder/file	Files	Notes/requirements for files
DS_DATA	cookbooks	COOKBOOK.XML Kochbuch_DE.xml cookbook_EN.xml etc.	<ul style="list-style-type: none"> • Number of visible characters in menu: 20 characters.
	pictograms	0100_bruehwurst.png 0200_fischterine.png 0500_blumenkohl.png 0500_karotten.png etc.	<ul style="list-style-type: none"> • Image file formats JPEG or PNG. • Image size for import maximum 2 MB. • The device software converts the imported image files as follows: size 480 × 270 pixels, resolution 72 pixels per inch, pixel depth 24, 16 million colours.
	sounds	Beep.wav Flipper.wav Klingel.wav etc.	<ul style="list-style-type: none"> • Sound format WAV, e.g. ring-tones for mobile phones or PC sound files can be used. • Filenames: maximum 30 characters. • Number of visible characters in menu: 10 characters. • Length of sound file maximum 20 seconds, audio format PCM, sampling rate 11/22/44 kHz, 16-bit quantisation, channels 1 or 2 (mono/stereo).
	userconfig- main.cfg specialpreps.xml		<ul style="list-style-type: none"> • These files contain the saved user settings. • Important: do not alter file content – this will cause malfunctions.

10.3 Data import: information about the "Replace/Add" key

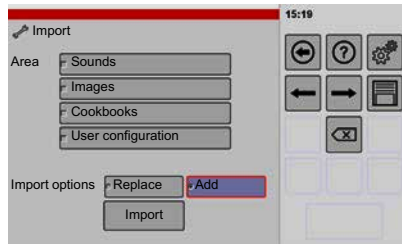

When you access the menu, "Add" is activated.

Important: when the "Replace" function is used, the folder content is first deleted before copying the data from the USB drive.

Function	"Replace" means:	"Add" means:
	<p>1. All files in the relevant folder in the control system are deleted.</p> <p>2. The files from the USB drive are copied to the relevant folder.</p> <p>Exercise care when using!</p> <p>Example: if the control system contains three cookbooks but there is only one cookbook on the USB drive, the "Replace" function will copy only one cookbook to the control system. This means the control system now has only one cookbook.</p> <p>Should be used if you want to standardise data across all appliances (e.g. you want to use the exact same cookbooks across all appliances).</p>	<p>Add files.</p> <p>When to use</p> <p>Should be used if you want to add data with a new filename.</p>
Sounds	<p>1. Important! All existing sounds in the "sounds" folder will be deleted.</p> <p>2. The sounds on the USB drive are copied to the "sounds" folder.</p>	<p>Sounds with different filenames are added to the "sounds" folder.</p> <p>Sounds with identical filenames are not changed.</p>
Images	<p>1. Important! All existing images in the "pictograms" folder will be deleted.</p> <p>2. The images on the USB drive are copied to the "pictograms" folder.</p>	<p>Images with different filenames are added to the "pictograms" folder.</p> <p>Images with identical filenames are not changed.</p>
Cookbooks	<p>1. Important! All existing cookbooks in the "cookbooks" folder will be deleted.</p> <p>2. The cookbooks on the USB drive are copied to the "cookbooks" folder.</p>	<p>Cookbooks with different filenames are added to the "cookbooks" folder.</p> <p>Cookbooks with identical filenames are not changed or overwritten.</p> <p>Example: The cookbook "Kochbuch_DE" exists. To add "cookbook_EN", the correct import function in this case is "Add".</p>
User configuration	<p>The "userconfigmain.cfg" and "specialpreps.xml" files will be overwritten.</p> <p>The appliance must be restarted to activate the new user configuration.</p>	<p>Not available.</p>

10.4 Exporting data – save data example

Examples of using exported data:

- To back up sounds, images, cookbooks and the user configuration.
- To import into other appliances in order to standardise user interfaces within a company.

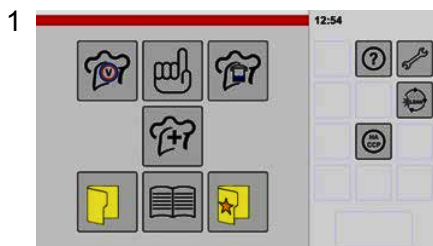

Starting screen settings/setup



☞ If the "Setup" icon is not shown, tap and hold the "Back" key briefly.

- The key display changes from "Back key" to "Home".



- The start screen is shown when you release the key.



☞ Tap the "Settings/Setup" key.

- The "Appliance data" window is shown.



☞ Continue to the next window – tap the arrow key.

- If a PIN (Personal Identification Number) has been enabled, you cannot move to the next window. Instead, the PIN entry window appears.

For information about entering or deleting the PIN, see from page 50, figure 9 and 10.

☞ Keep tapping the arrow key until the "Export" window appears.



Progress bar

Data export: control system -> USB drive



Export

☞ Insert the USB drive into the USB port.

- Wait approx. 5 seconds until the control system has connected to the USB drive.

☞ Tap the selection you want to use for data export.

- The selected data type is highlighted in colour and shown with a border.



☞ Tap the "Export" key.

- The copying process is executed (takes approx. 5 to 30 seconds depending on the amount of data).
- A message appears after completion.



☞ Tap the "Confirm" key.

- The message disappears.

☞ Remove the USB drive.

☞ To back up the exported data, copy the data from the USB drive to a PC or laptop.

- Creating a copy in this way ensures you have a data backup. You can use this data again if required.

10.5 Importing data – replace cookbook(s) example

You can use this function to standardise cookbooks across multiple appliances, for example.

As a precaution, export your existing data to a separate USB drive before replacing data (*For instructions about exporting, see section 10.4*)

For information about data import requirements, see page 58 , section 10.2

1



Starting screen settings/setup



☞ If the "Setup" icon is not shown, tap and hold the "Back" key briefly.



- The key display changes from "Back key" to "Home".
- The start screen is shown when you release the key.



☞ Tap the "Settings/Setup" key.

- The "Appliance data" window is shown.



☞ Continue to the next window – tap the arrow key.

- If a PIN (Personal Identification Number) has been enabled, you cannot move to the next window. Instead, the PIN entry window appears.

For information about entering or deleting the PIN, see from page 50 , figure 9 and 10.

☞ Keep tapping the arrow key until the "Import" window appears.

- The "Add" key is highlighted in colour and shown with a border.

2

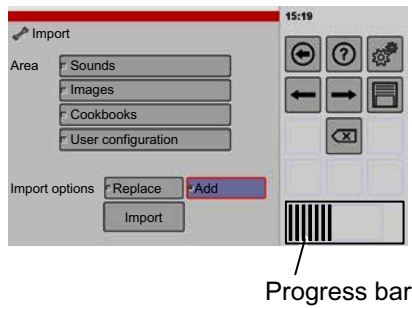

Data import: USB stick -> control system



Importing (example: replacing all cookbooks in the control system)

- ☞ Insert the USB drive into the USB port.
 - Wait approx. 5 seconds until the control system has connected to the USB drive.
 - Important: the "Replace" function deletes existing data! *Follow the instructions in section 10.3.*
- ☞ Tap the data you want to import, e.g. a cookbook.
 - The selected data type is highlighted in colour and shown with a border.



- ☞ Tap the "Replace" key.
 - The "Replace" key is highlighted in colour and shown with a border.



- ☞ Tap the "Import" key.
 - The copying process is executed (takes approx. 5 to 30 seconds depending on the amount of data).
 - A message appears after completion.



- ☞ Tap the "Confirm" key.
 - The message disappears.
 - The data is imported into the control system.
 - The imported data is available only after the appliance has been restarted.
 - Activating a new imported cookbook after restarting: Select and save the new cookbook in the control system, see page 49 , figure 8.

11. Cleaning and care

Keep the appliance and the cooking chamber clean. Reheating old grease and food residues will impair the odour and taste of food being cooked.

Instructions

- Clean the appliance/cooking chamber at least once a day, depending on the level of soiling.
- Before extended stoppages in which the appliance cools down, clean the cooking chamber immediately after use (risk of clogging due to solidifying grease or food residues drying and adhering to the chamber).
- Do not use any caustic cleaners on the control panel or cooking chamber door.
- Do not spray or clean the appliance with water hoses, pressure washers, high-pressure steam cleaners or steam cleaners.
- Follow the instructions supplied by the cleaning agent manufacturer.
- Do not use any sharp or pointed objects for cleaning.
- Do not clean the appliance and the cooking chamber with acids or expose them to acid vapours, as the surfaces will be damaged and may become discoloured.
- Wear protective clothing such as gloves and safety goggles while cleaning the appliance.

11.1 Important information about stainless steel (risk of corrosion)

- Please note! Even high-quality stainless steel can corrode if handled improperly. Salt, acids, chlorine, iodine and food residues destroy the protective coating, and can cause corrosion and pitting even in high-quality stainless steel.
- While the stainless steel surface creates a new protective coat after damage, this only happens if air or oxygen-rich water has time to react with the surface.
- If the cooking chamber is not cleaned carefully, residues such as limescale, proteins or starch can be left on the stainless steel surface. If these residues are not completely removed, this prevents air or oxygen-rich water from getting to the stainless steel surface. Accordingly, no protective coating can be formed, which results in corrosion such as pitting – even on high-quality stainless steel. Always ensure you clean thoroughly to prevent any residues being left on the surface.

11.2 Cleaning stainless steel surfaces

- ☞ Clean stainless steel surfaces with a cleaner-degreaser or a special stainless steel maintenance product.
- ☞ Thoroughly wipe down the cleaned surfaces with a clean, damp dish cloth, without the use of any cleaning agent.
- ☞ Rub cleaned surfaces dry with a soft, lint-free cloth.

11.3 Cleaning and care of the seal on the cooking chamber door

The service life of the seal depends very much on how it is cared for. Harsh cleaning materials attack the seal material and accelerate wear and tear.

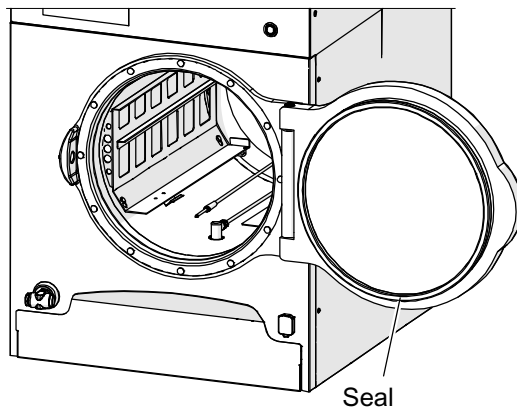

Cleaning the seal

- ☞ Turn off the appliance and let it cool down.
- ☞ Remove the seal and clean using a cleaner-degreaser, then rinse and dry.
- ☞ Thoroughly clean and rub dry the seal seat.
- ☞ Rub a thin coat of a food-grade emulsion (kitchen oil) or cooking oil onto the seal.
 - SALVIS Non-Stick, Protection and Care (care emulsion) 0.5 l – item no. ET100060
- ☞ Insert the seal.

If steam escapes from the seal:

- ☞ Remove and clean the seal. Then rub a thin coat of a food-grade emulsion (kitchen oil) or cooking oil onto the seal.
 - The seal must be replaced if is worn.

11.4 Cleaning the cooking chamber and the drip tray

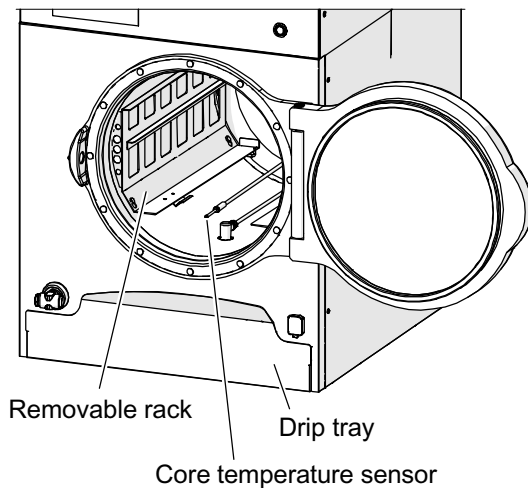

- ☞ Turn off the appliance and let it cool down.
- ☞ Place the core temperature sensor and its wire in the cooking chamber.
- ☞ Unhook the removable racks, and remove and clean daily with a cleaner-degreaser or in a dishwasher.
- ☞ Clean the cooking chamber with a cleaner-degreaser and rub dry.
- ☞ Clean the drain screen and insert.
- ☞ In the event of limescale
 - Clean the cooking chamber with a descaling agent
 - Regenerate the water softener, see page 66 , section 12.
- Leave the cooking chamber door open after cleaning.
- Do not use a grill cleaner, because this will destroy the special cooking chamber surface.

Daily/weekly: Rinse the drain and the valves, see page 65 , section 11.5.

11.5 Rinsing and cleaning the drain and valves

Daily: perform this rinsing and cleaning procedure daily.

Weekly: perform the rinsing and cleaning procedure with ice cubes once a week.

- During the rinsing and cleaning procedure, the drain lines and the drain valve are cleaned.
- Adding ice to the cooking chamber also flushes water through the drainage system.
- This cleaning procedure does not use any cleaning agents.
- Duration of rinsing and cleaning procedure approx. 10 minutes.

Before starting the rinsing and cleaning procedure

- ☞ Remove food residues from the cooking chamber and drain screen.
- ☞ Weekly: fill perforated Gastronorm containers with approx. 2.5 kg of ice cubes and place in the cooking chamber.
- ☞ Close the cooking chamber door.



Starting the cleaning process



- ☞ Tap the "Cleaning" key.
- The "Cleaning" window is shown.

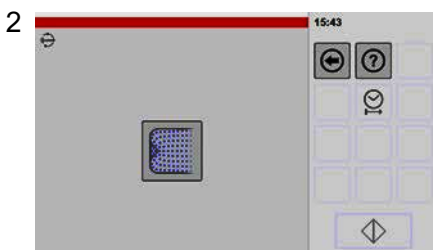

Selecting the cleaning process



- ☞ Tap the "Cleaning" key.
- The "Cleaning" window is shown.

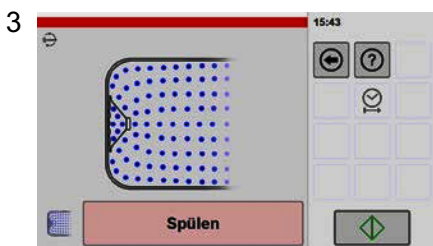

Starting the cleaning process



- No rinse cycle is started yet.
- ☞ Tap the "Start/Stop" key.
- A message appears: Fill a Gastronorm container with ice cubes and place in cooking chamber.

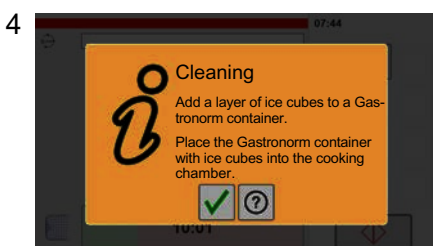

Confirming placement of Gastronorm container with ice cubes



- If the container with ice cubes has been placed in the cooking chamber, the message can be confirmed immediately.
- ☞ Tap the "Confirm" key.
- The "Cleaning" window is shown.

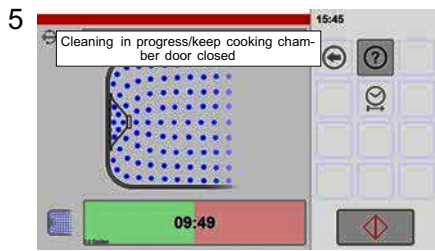

Cleaning process

- The progress bar indicates the time left for the process.

Once the cleaning process has completed:

- The "Cleaning program" display disappears
- The "Start screen" display appears
- Perform manual cleaning tasks, *see from page 64, section 11.3 and 11.4.*

12. Regenerating the water softener



Please be aware that the regeneration process takes approximately 45 minutes. Always schedule the regeneration process at times when you are not cooking.

Requirements for regeneration salt

Use regeneration salt with a grain size of 1.4 to 4 mm.

Do not use cooking salt. Cooking salt not only reduces the efficiency of the water softener but can also damage the ion-exchange resins.

12.1 Regeneration prompts

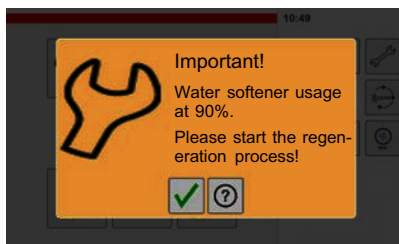

Usage at 90%

- If water softener usage is at 90%, you are shown a prompt stating that the water softener regeneration now needs to be started.
- To avoid interrupting normal business operations, regeneration can also be scheduled for completion at a later point in time.

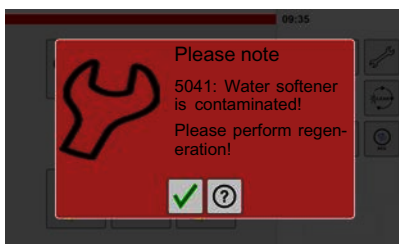

Usage at 95%/contaminated

- If water softener usage is at 95%, the water softener regeneration must be started immediately. This message is also shown if the regeneration process was interrupted (water is contaminated).
- The appliance cannot be used until the water softener regeneration process has been completed.

12.2 Starting the regeneration process

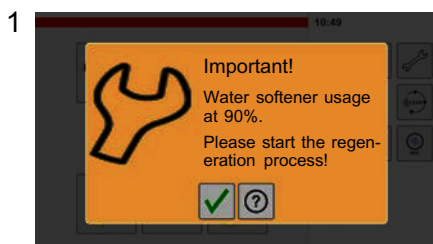

Regeneration process prompt

- You are prompted to regenerate the water softener before water softener usage reaches 100%.



☞ Tap the "Confirm" key.

- The start screen is shown, as well as the "Regenerate" key.

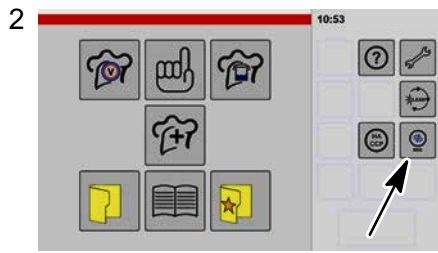

Opening the regeneration window



- Tap the "Regenerate" key.
- The "Regeneration" window is shown.



Starting the regeneration process



- The symbol in the "Start/Stop" key lights up green.
- Tap the "Start/Stop" key.
- The message "Open water softener lid" is displayed.

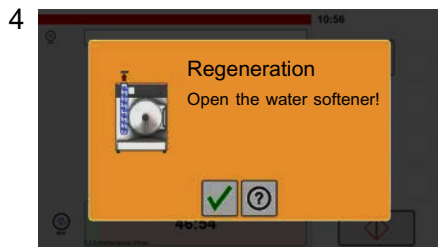

Prompt to remove the water softener lid



- Unscrew the water softener lid from the water softener.



- Tap the "Confirm" key.
- A message about regeneration is shown.

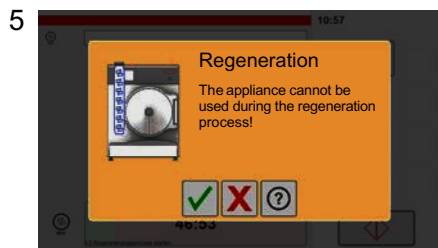

Message about use during the regeneration process

The regeneration process can still be cancelled at this point.



- Tap the "Confirm" key.
- Water is drained from the water softener (duration approx. 1 minute).
- After the draining process: you are prompted to fill the softener with regeneration salt.

Key legend:



Confirm



Cancel

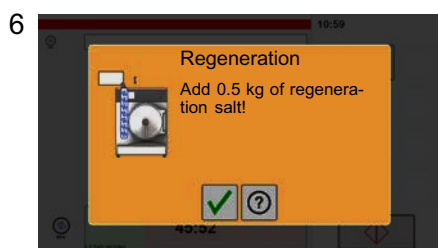

Prompt to add regeneration salt



- Fill 0.5 kg of regeneration salt (grain size 1.4 to 4 mm) into the water softener.

Tap the "Confirm" key.

- The prompt "Close the water softener lid" is shown.



Prompt to replace the water softener lid



- Important! Screw the water softener lid back on tightly: this avoids any risk of water escaping from the water softener.



- ☞ Screw the water softener lid onto the water softener.



- ☞ Tap the "Confirm" key.
- The "Regeneration process" window is shown.

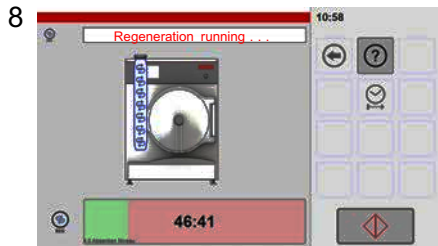

Regeneration process window

- The symbol in the "Start/Stop" key lights up red.
- The regeneration process now completes.
- The timer runs down. The remaining time is displayed.
- The progress bar provides a graphical display of the elapsed time.
- The control system determines the conductivity of the water. If the regeneration salt has not been fully dissolved, a prompt is shown informing you that the regeneration process must be repeated.
- Once the regeneration process has completed, the start screen is shown.

Key legend:



The regeneration process can be interrupted by tapping the "Start/Stop" key.

Important! If the regeneration process is cancelled, no work can be performed with the pressure steamer. The regeneration process must be repeated and must complete properly before the control system allows the appliance to be used.



After regeneration has completed

- The start screen is displayed.
- The "Regenerate" symbol is hidden.

13. Faults and troubleshooting

If faults occur with the appliance, please check these faults against the following table:

Fault	Possible cause	Remedy
Display screen does not respond after switching on the appliance.	Main switch upstream of the appliance not turned on.	Turn on the main switch.
	General power failure.	Inform the utility company.
	Mains fuse has tripped.	Have potential faults in the appliance checked by an authorised customer service technician. Reset the mains fuse.
The appliance is switched on but does not heat up.	An upstream load-shedding unit is stopping the heater from working.	Check the load-shedding unit.
Control/display panel does not respond to touch commands.	Control panel is not calibrated/aligned properly. Touch screen sensitivity is incorrect.	Calibrate the control panel, see page 47 , figure 5. Adjust the touch screen sensitivity, see page 46 , figure 4. If the control panel (touch screen) still cannot be used after recalibration and resetting the sensitivity: <ul style="list-style-type: none"> – Connect a PC mouse to the USB port. Operate the control panel (touch screen) with the PC mouse. – Inform the authorised Customer Service. A connected PC mouse is recognised only after restarting the appliance.
Water does not drain out of the cooking chamber.	The drain outlet is blocked.	Clean the drain screen.
Stains in the cooking chamber	Seasoning added before cooking.	Add seasoning after cooking.
Steam escapes from the cooking chamber door.	The seal is still cold or dry.	Remove and clean the seal. Then rub a thin coat of a food-grade emulsion (kitchen oil) or cooking oil onto the seal.
	The seal is worn or faulty.	Replace the seal on the cooking chamber door.
Limescale build-up on the cooking chamber walls.	The water softener is used up or incorrectly configured.	Regenerate the water softener and have it configured by the authorised Customer Service. To regenerate the water softener, see page 66 , section 12.

Fault	Possible cause	Remedy
The pull-out shower head is leaking or faulty.	Leaks, limescale deposits, material fatigue.	To continue using the appliance, you can deactivate the use of the pull-out shower head in the software (see page 54, figure 15). For repairs, notify the authorised Customer Service.
Corrosion in the cooking chamber	<p>Poor water quality</p> <p>Incorrect cleaner/cleaning</p> <p>Limescale, grease, starch and protein residues not properly removed.</p> <p>Iron present in the water supply.</p>	<p>Filter the water. Follow the installation instructions.</p> <p>Follow the cleaning instructions.</p> <p>Clean the cooking chamber thoroughly. Ensure that every last particle of residue is removed from the surface of the cooking chamber. Corrosion can form under these residues.</p> <p>Remove all on-site water supply pipes made from iron/stainless steel.</p>
<p>Pressure cooking:</p> <p>After the cooking process has finished, the cooking chamber door cannot be opened.</p>	<p>The setting for "Height above sea level (NHN)" is not configured correctly.</p> <p>The water drain is blocked. The positive pressure cannot dissipate. The drain hose may be kinked or squashed, for example.</p> <p>The water drain connection has not been made properly and correctly.</p>	<p>Wait until the positive pressure has dissipated by cooling.</p> <p>Have the height above sea level configured by a customer service technician (see also page 79 section 15.11).</p> <p>Ensure the drain hose is laid properly (see page 77 section 15.7).</p> <p>Ensure the water drain is installed professionally (see page 77 section 15.7).</p> <p>If you still cannot open the cooking chamber door once the pressure has dissipated, please contact the customer service team.</p>
Fault display: Nos. 2003, 2004	Communication fault in the control system.	Switch off the appliance for 1 minute. If the fault occurs again, contact the authorised Customer Service.

Fault	Possible cause	Remedy
Fault display: No. 3001	<p>Protective/safety mechanism in appliance is not responding.</p> <p>The appliance was moved at temperatures below zero.</p> <p>Frozen products were stored in the cooking chamber.</p> <p>The safety temperature limiter has tripped because the appliance has cooled to below -5°C.</p>	<p>Open the cooking chamber door, allow the appliance to cool.</p> <p>Turn the appliance off and on.</p> <p>If the fault occurs again, contact the authorised Customer Service.</p> <p>Set up the appliance in a warm dry room.</p> <p>Open the cooking chamber door.</p> <p>When the safety temperature limiter has warmed up to above $+5^{\circ}\text{C}$, the safety temperature limiter will automatically switch back on.</p>
Fault display: Nos. 3003, 3004	Temperature sensor in the cooking chamber is not responding or has short-circuited.	<p>Turn the appliance off and on.</p> <p>If the fault occurs again, contact the authorised Customer Service.</p>
Fault display: No. 3005	Cooking chamber too hot	<p>Switch off the appliance. Open the cooking chamber door and allow the cooking chamber to cool.</p> <p>If the fault occurs again, contact the authorised Customer Service.</p>
Fault display: Nos. 3006, 5001	Electric compartment too hot. The appliance is being heated by heat sources near to the appliance.	<p>Allow the appliance to cool. Follow the setup instructions.</p> <p>If the fault occurs again, contact the authorised Customer Service.</p>
Fault display: No. 4003	Water drain too hot	<p>Open the water tap. Allow the appliance to cool.</p> <p>If the fault occurs again, contact the authorised Customer Service.</p>
Fault display: No. 4040	The core temperature sensor function has been activated in software, but there is no core temperature sensor present in the appliance.	Notify your authorised customer service representative.
Fault display: Nos. 4042, 4060, 4064	Sensor not responding or has short-circuited.	<p>Turn the appliance off and on.</p> <p>If the fault occurs again, contact the authorised Customer Service.</p>
Fault display: Nos. 4081 to 4086	Incorrect water level in steam generator.	<p>Check the water supply.</p> <p>If the fault occurs again, contact the authorised Customer Service.</p>

Fault	Possible cause	Remedy
Fault display: No. 4087	Steam generator taking too long to heat up.	Check building fuses to see if one or more has tripped. Have an electrician check whether the appliance is being properly supplied with all three phases. If the fault occurs again, contact the authorised Customer Service.
Fault display: No. 4088	The regeneration process did not complete. The regeneration salt has not dissolved completely.	The regeneration process must be repeated without adding regeneration salt. For instructions about starting the regeneration process, see page 66 , section 12.2.
Fault display: No. 5005	Battery for buffer storage is nearly empty.	Have the authorised Customer Service replace the battery (coin cell) in the appliance.
Fault display: Other numbers	Other	Make a note of the fault number. Turn the appliance off and on. If the fault continues to occur, contact authorised Customer Service and inform them of the fault number.

If you cannot remedy the fault:

- Switch off the appliance and disconnect it from mains power.
- Do not open the housing.
- Contact Customer Service.

14. Technical data

Technical data	Pressure Steamer D311S . . .
Cooking chamber capacity	3x GN 1/1-65 2x GN 1/1-100 1x GN 1/1-200
Article no.	D311S . . .
Voltage, total connected load and fuses	16 kW 400 V 3N 50 Hz 3x 25 A 16 kW 230 V 3 50 Hz 3x 40 A 16 kW 440 V 3 50 Hz 3x 25 A
Thermal output, sensitive:	0.62 kW
Thermal output, latent:	0.16 kW
Steam output:	0.23 kg/h
Cold water supply diameter	G 3/4 inch
Water drain diameter	20 mm
Water consumption per hour	up to 30 l/h (approx.)
External dimensions, incl. cooking chamber door and lid (L × W × H)	624 x 844 x 867 mm
Weight	104 kg (approx.)
Appliance noise emissions	Less than 70 dB (A)

Technical specifications subject to change without notice.

15. Setup and connections

- Please observe local regulations applying to commercial kitchens.
- Installation work must be carried out in accordance with the manufacturer's assembly instructions and recognised industry best practice.
- Do not place/stack other appliances on this appliance.
- The setup, installation and connection work listed here must be carried out by professional fitters/ installation personnel.
- Observe the safety instructions!

15.1 Appliance warm-up



Important: risk of damage! Let appliance warm up before connecting!

If the appliance is stored or moved at very low or below-zero temperatures, always let the appliance warm up properly before connecting it up:

- At a room temperature of over 10 °C/50 °F, for example
- Warm-up time at least 24 hours
- Ensure condensation water in and on the appliance has dried.
- Any residual water present in the circulation system must have thawed out.

15.2 Transporting the appliance



IMPORTANT! Risk of damaging seals on the underside of the appliance!

- Take care not to damage the seals during transportation.
- Remove the in-transit protection only once all supply/drain lines are connected and the appliance has been set up at its final installation site.

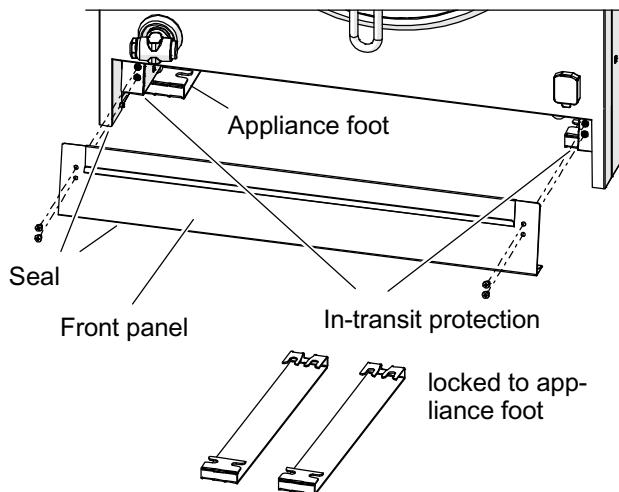

Condition when delivered

A seal is fitted to the underside, front and sides of the appliance.

- This seal prevents dirt getting underneath the appliance and also stops the appliance from sliding about when installed.

In-transit protection is fitted to the appliance feet (left and right).

- A piece of felt is attached to the underside of the in-transit protection to make it easier to move the appliance at the installation site.

☞ Use a pallet truck or forklift to move the appliance to the installation site on the cargo pallet.

☞ Wear protective gloves!

- Remember – the appliance is very heavy! Always work with proper back posture.
- Risk of damage! If the appliance is stored or moved at temperatures below zero, let the appliance warm up properly before connecting it up:
 - At a room temperature of over 10 °C/50 °F, for example
 - Warm-up time at least 24 hours

15.3 Information about the installation site

- Set up the appliance so that operators can see the Gastronorm containers in the cooking chamber.
- Provide adequate clearance above the appliance. Topping-up regeneration salt must be easy and straightforward.
- Provide adequate space to stand when operating the appliance. This space should be adequate for using the appliance without a risk of personnel hitting other personnel with tools, etc.
- If the appliance is operated in areas with customers, install appropriate machine guards to ensure that customers cannot come into contact with the appliance.

15.4 Setup



- Minimum clearances
 - 50 mm on each side (left and right)
 - 20 mm at the rear (for angled Ethernet connectors, clearance of >50 mm is required)
 - Do not set the appliance up adjacent to/on heat sources.
 - Do not set the appliance up on tables or stands that are too high. When removing liquid cooked products, spilled product can cause scald injuries. Ensure that operating personnel have a clear view of the containers in the cooking chamber. The appliance must be installed so that the height of the upper input module does not exceed 1.60 metres/63 inches.
- ☞ Ensure the stand or table is levelled before placing the appliance on it.
- To complete setup properly, ensure that there is an elevation drop in the cooking chamber to the cooking chamber drain.
- ☞ Remove the protective film from the appliance. Remove adhesive residues with a solvent or white spirits.

Important information about appliance feet

- The appliance feet are already set to the final height. Do not adjust the appliance feet!
- When the in-transit protection is removed, the appliance is set down on the seal.

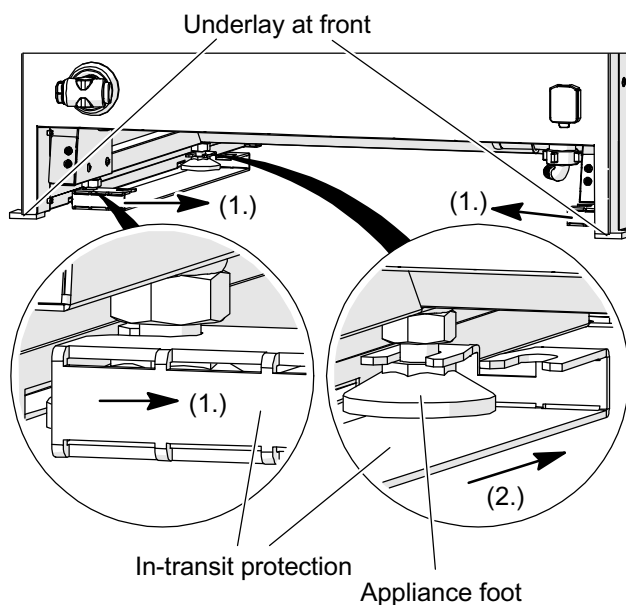

- ☞ Remove the front panel.
- ☞ Connect up all the supply and drain lines.
- ☞ Position the appliance at its final location.

Removing the in-transit protection

- ☞ Lift the appliance at the front and lay under to the left and right.
- ☞ (1.) Pull the in-transit protection forwards and out of the front appliance foot, as shown by the arrow.
- ☞ (2.) Pull the in-transit protection backwards and out of the rear appliance foot, as shown by the arrow.
- ☞ Store the in-transit protection under the appliance for later maintenance/service work.

Fitting the front panel

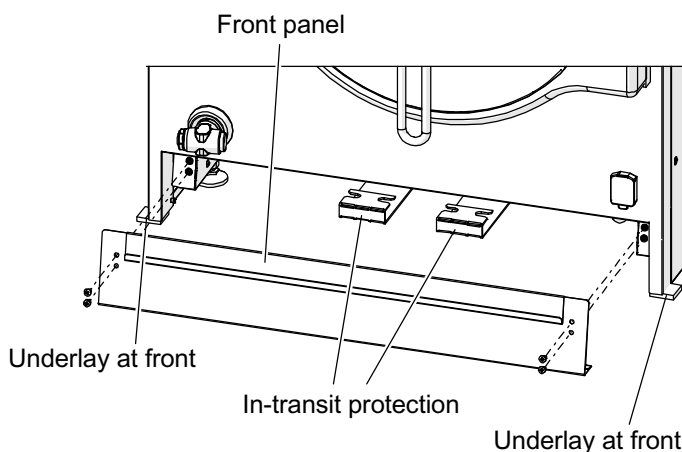

- ☞ Lift the appliance again at the front and lay under to the left and right.
- ☞ Fit the front panel, taking care to ensure that all seals are flush with the seals on the side.
- ☞ Lift the appliance at the front and remove the underlays.

- If appliances are set up as standalone units on narrow stands, tables or other structures: prevent the appliance and stand, table or other structure from tipping over or shifting – e.g. by screwing it to the wall.

15.5 Connections

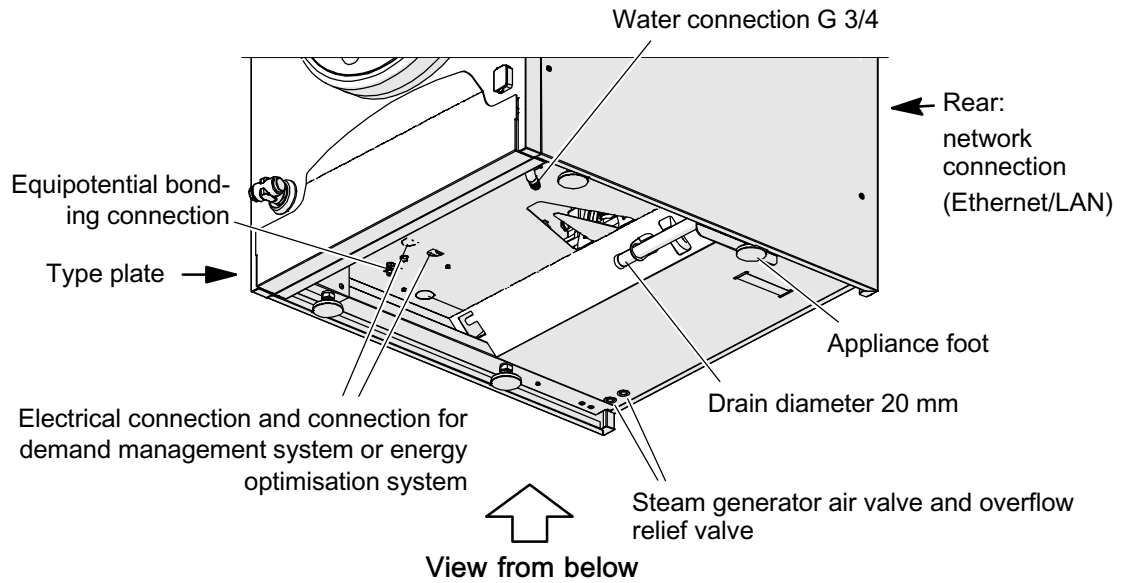

15.6 Water connection



- Observe the regulations issued by the local water utility company.
- Do not connect to a hot water supply, instantaneous water heater or unpressurised hot water appliances.
- The appliance must be operated with cold drinking water.
- A water tap and a water filter (50 microns) must be installed in an easily accessible position upstream of the appliance.
- Water pressure (cold water):
 - At least 200 kPa (2 bar), dynamic: the working pressure must not drop below 200 kPa due to additional consumers – install a separate water inlet or pressure booster pump if required.
 - Maximum 350 kPa (3.5 bar), static: at pressures above 350 kPa (3.5 bar), install a pressure regulator upstream of the appliance.
- The appliance has a built-in water softener. This must be configured by the authorised Customer Service. For instructions about regenerating the water softener, see page 66 , section 12.
- As standard, appliances are supplied prepared for connection to a drinking water supply. If the appliance needs to be connected to an osmosis filter system:
 - Special appliance settings must be made by the authorised Customer Service
 - The conductivity of the water produced by the osmosis filter system must be between 2 and 50 $\mu\text{S}/\text{cm}$.
- Install an approved check valve/backflow prevention device between the water tap and inlet hose (type EA with inspection facility – article no. 886240).
- Always use connecting hoses that are tested, pressure-resistant, flexible, food-grade quality and certified. Maximum length of connecting hose 2000 mm.
- The supply hose must not be kinked or squashed flat anywhere along its length.
- Flush out the water supply line and the supply hose before connecting.
- Check that all connections are watertight.

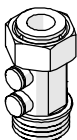

15.7 Water drain

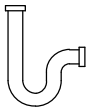

- The hoses and waste pipes used must be heat-resistant to $>100^{\circ}\text{C}$.
- Lay the waste pipe and hose with an elevation drop of at least 3% to the drain.
- Ensure that the waste pipe does not become narrower along its length.
- Do not connect the appliance directly to the drain. The connection must be made using the options shown below.
- **Important: risk of damage!** Always route the water drain as shown below.

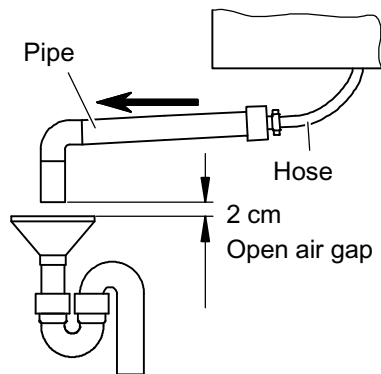

Drain with open air gap

- Drain pipe with air gap to tundish.
- Do not place the tundish directly underneath the appliance or in its base unit/stand.
- Ensure an air gap of at least 2 cm gap between the drain pipe and tundish upper edge.

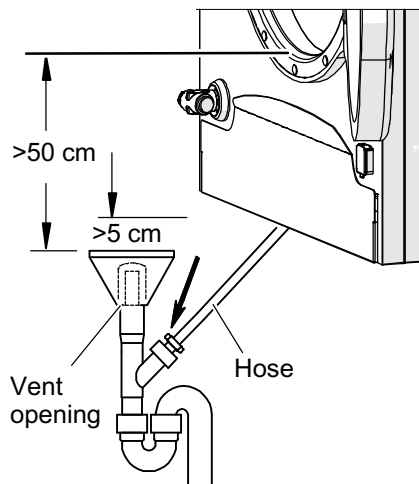

Permanent connection with vented tundish

- Do not place the tundish directly underneath the appliance or in its base unit/stand.
- The vent opening must be located at least 50 cm underneath the cooking chamber drain.

15.8 Connecting to the electrical power supply



DANGER! Hazardous electric voltage!

Risk of electric shock that could result in serious injury or death!

- All electrical work must be carried out by the authorised Customer Service or a qualified electrician.
- ☞ Switch off the appliance and lock it out so it cannot be switched back on.
- Consult the data on the type plate and the wiring diagram enclosed with the appliance when making electrical connections.
 - Electrical connections must be completed according to applicable local regulations (e.g. VDE 0190 in Germany) and guidelines from the local utility company.
 - The minimum standard for the flexible mains lead is compliance with H 07 RN-F.

- For safety reasons, we recommend installing a >10 mA residual current device (RCD).
- Integrate the appliance into the equipotential bonding system. The effectiveness of this system must be inspected according to local regulations (e.g. VDE 0190 in Germany).
- Make sure that the protective conductor system for the in-house electrical installation is installed according to regulations.
- An electrical main switch must be installed upstream and must be easily accessible. The switch must reliably disconnect and isolate the appliance from the electrical system. The contact opening must be at least 3 mm.
- Inform the operating company and the operating personnel of the location of the main switch in the building to ensure that the appliance can be switched off safely in the event of hazards to operators.
- Set the appliance's rotary switch to off before activating the mains power supply.
- For appliances with power plugs, the power socket must be easily accessible.

15.9 Connecting to an energy optimisation unit (optional)

Wiring diagram example

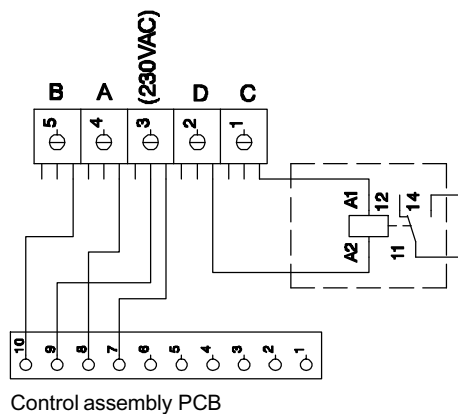

- The appliance is fitted with the necessary interface (ABCD interface) at the factory.
 - A = Appliance switched on
 - B = Appliance is heating
 - C = Request (energy optimisation unit)
 - D = Neutral conductor (N)
- An energy optimisation unit must be connected by an electrical technician or the authorised Customer Service.
- Consult the wiring diagram.

15.10 Connecting to a load-shedding unit (optional)

- Load-shedding units switch off power to consumers in the event of power peaks.
- If switched off by the load-shedding unit, the cooking chamber heater is switched off.
- Any ongoing heating and cooking operations are not taken into account.

Connection

- A load-shedding unit must be connected by a qualified electrician or the authorised Customer Service.

15.11 Settings – water softener and height above sea level

If the default settings are not appropriate for local conditions, please notify your customer service team. These settings must be adjusted only by an authorised customer service technician.

Setting options	Default (factory) settings	Description
Deactivate water softener	Deactivate water softener = OFF	OFF = The water softener in the appliance is used.
Hardness scale	Germany	Values are used as appropriate for the country setting. Germany = German degrees of hardness = °dH UK = British degrees of hardness = °e France = French degrees of hardness = °fH
Hardness	20	Adjust the water hardness to local conditions.
Height above sea level	500	Height above sea level ("NHN" in Germany) Set in metres using the following steps: 0 - 500 - 1000 - 1500 - 2000 - 2500 - 3000 – If set incorrectly, you will not be able to open the cooking chamber: The positive pressure in the cooking chamber will not be reduced even though the cooking process is complete and the acoustic signal sounds.

For operation with osmosis water

(settings made by customer service technician)

- The built-in water softener must be switched off ("Deactivate water softener" = ON).
- The conductivity measurement sensitivity must be switched over.

15.12 Commissioning

After being switched on for the first time, the steam generator and water softener are filled with water automatically (duration approx. 2 min). The steam generator heating-up process then starts. (Total duration approx. 8 min.)

16. Maintenance



DANGER! Hazardous electric voltage!

Risk of electric shock that could result in serious injury or death!

- Maintenance work on electrical appliances must be carried out by the authorised Customer Service or a qualified electrician.

☞ Switch off the appliance and lock it out so it cannot be switched back on.

- Arrange annual inspection and maintenance for this appliance. Maintenance tasks include safety checks, functional tests and inspections for leaks.
- Always use genuine accessories and spare parts.
- We recommend taking out a maintenance contract with the Customer Service.

17. Disposing of old appliances

- Before dismantling, switch off the appliance at the mains and lock it out so it cannot be switched back on. Then disconnect the mains cable from the mains socket and from the appliance.
- Follow local and national regulations when disposing of regeneration salt/water softener.
- Old appliances are not worthless rubbish! Valuable raw materials can be recovered by environmentally friendly waste disposal.
- Always observe the relevant legal requirements when disposing of the appliance.
- Do not dispose of commercial electrical appliances via the municipal waste collection system or include them in household waste.



18. Translation of ECDeclaration of Conformity

This declaration relates only to the appliances in the condition in which they were placed on the market. The declaration is invalidated if the product has been converted or modified without consent.

We hereby declare that the machines identified below comply with the appropriate provisions of the Machinery Directive 2006/42/EC on the basis of their design and construction, and in the versions placed on the market by us. The machines additionally comply with the provisions of Directive 2014/35/EU concerning electrical equipment and 2014/30/EU concerning electromagnetic compatibility.

Machine types

Pressure Steamer D311S . . .

Harmonised EN standards applied

DIN EN 60335-2-42, DIN EN 55014-1, DIN EN 55014-2, DIN EN 61000-3-2, DIN EN 6100-3-11

Person authorised to compile the technical file

SERVATOR ServiceLine GmbH, Thomas Schmalz, Lindenweg 36-42, 97999 Igersheim, Germany

19. Software declaration

The software used in this appliance includes software supplied with a "General Public Licence" (GNU). The license certificate can be found in its original English version at the following internet address: "<http://www.gnu.org/licenses/gpl.html>". This free software does not include the free distribution of our libraries.

Artikel-Nr. 889860 / 7.19 / 10.19

SALVIS AG
Nordstrasse 15
4665 Oftringen, Switzerland
Phone: +41 62 788 18-18
Fax: +41 62 788 18-98
Internet: www.salvis.ch
Email: info@salvis.ch

smart cooking

